

Collection 2019



Mercedes-Benz

As at: March 2019. Please note: changes may have been made to the products since this publication went to press (12/2018). The manufacturer reserves the right to make changes to the design, form, colour and specification during the delivery period, provided these changes, while taking into account the interests of the vendor, can be deemed reasonable with respect to the purchaser. Where the vendor or the manufacturer uses symbols or numbers to describe an order or the subject of an order, no rights may be derived solely from these. The illustrations may include accessories and items of optional equipment which are not part of standard specification. Colours may differ slightly from those shown, owing to the limitations of the printing process. This publication may include products and services which are not available in certain countries. Information given regarding statutory regulations, legal requirements and taxation and the consequences thereof applies to the Federal Republic of Germany only and is correct at the time of going to print. Please consult your Mercedes-Benz Retailer for final details. Prices subject to change.

Provider: Daimler AG, Mercedesstr. 137, 70327 Stuttgart  
Mercedes-Benz Accessories GmbH – A Daimler Company

3240 · 0005 · 42-01/0319 Printed in the Federal Republic of Germany  
© 2019 Mercedes-Benz Accessories GmbH. All rights reserved.

Collection 2019

Mercedes-Benz





# Contents



2	The Mercedes-Benz Collection
52	The Mercedes-Benz Classic Collection
64	The Mercedes-Benz Van Collection
70	The Mercedes-Benz Trucks Collection
76	The Mercedes-Benz Motorsports Collection
84	The Mercedes-AMG Collection



SCAN THE QR CODE AND EXPERIENCE THE COLLECTION.

[http://mb4.me/MBA\\_MB\\_Collection](http://mb4.me/MBA_MB_Collection)

**MEN'S CAGOULE**  
 Black / grey blend. 100% polyester. Low weight. Longer cut back section with ventilation slits. Side pockets with water-resistant zippers. High-closing, water-resistant front zipper. Water-resistant taped seams. Hood adjustable in size and width. Cuffs and seam adjustable in width. Elastic cuffs with thumb hole on sleeve ends. Incorporated bag in the back section for compact storage of jacket. Modern fit. silver-coloured Mercedes star print on the left sleeve, black Autoblock zip puller with Mercedes star in 3D look, "Mercedes-Benz" lettering on the inside of the seam. Sizes: S-XXL.  
 B6 695 8701-8705  
 \$124.95

**MEN'S POLO SHIRT**  
 100% cotton. Short-sleeve shirt with spiral zip and black zip puller. Zip front with stylish bonding. Patterned neck and side groove bands. Single-rib collar and cuffs. Drop-tail cut. Modern fit. Sizes S-XXL.  
**Grey** B6 695 8711-8715  
**Black** (not shown) B6 695 8706-8710  
 \$78.95

# Freestyle.

Casual meets chic. Elegance meets sportiness. Business meets leisure. The Mercedes-Benz Collection combines the elegance unique to our vehicles with superior sportiness. For all those who have nothing left to prove. And display the best of what makes life more beautiful: accentuated nonchalance.



THE MERCEDES-BENZ COLLECTION

**1 LITE CUBE CASE 55**

Dimensions approx. 40 x 20 x 55 cm.  
Capacity approx. 38 l, weight approx. 2.2 kg.  
**Black** B6 695 8486  
**Hyacinth red** (not shown) B6 695 8489  
**Denim blue** (not shown) B6 695 8483  
\$670.95

**2 LITE CUBE CASE 69**

Dimensions approx. 46 x 27 x 69 cm.  
Capacity approx. 75 l, weight approx. 2.7 kg.  
**Black** B6 695 8487  
**Hyacinth red** (not shown) B6 695 8490  
**Denim blue** (not shown) B6 695 8484  
\$759.95

**3 LITE CUBE CASE 75**

Dimensions approx. 52 x 75 x 31 cm.  
Capacity approx. 93 l, weight approx. 3 kg.  
**Black** B6 695 8488  
**Hyacinth red** (not shown) B6 695 8491  
**Denim blue** (not shown) B6 695 8485  
\$812.95

**1-3 LITE CUBE CASE**

Highly impact-resistant material (Curv®). Functional interior trim with adjustable packing straps and two dividers. Smooth-running, silent double wheels. TSA lock. Incl. shoe bag and laundry bag. By Samsonite for Mercedes-Benz.



**WEEKEND BAG**

Black. Polyurethane/polyester. Water-repellent. Large main compartment with 2-way zip. Zipped inner pocket. Adjustable, detachable shoulder belt. Volume approx. 60 l. Dimensions approx. 60 x 30 x 34 cm. B6 695 5033  
\$216.95

**MEN'S SPORT FASHION M3 CHRONOGRAPH**

Stainless steel case with black PVD coating. Black dial. Hour and minute hands, as well as blue second hand with Super-LumiNova® detail. Anti-reflective mineral glass on both sides. Black nylon strap, blue woven coloured stripes running through the middle. Water-resistant to 10 ATM. Diameter 42 mm. Ronda 5030 quartz movement. Swiss made. B6 695 4061  
\$415.95



**4 RUCKSACK**  
Black. Polyurethane/polyester. Water-repellent. Main compartment with 2-way zipper and various inner compartments. Zipped compartment on front. Padded back section. Trolley attaching function. Adjustable, padded shoulder belt. Carrying handle. Dimensions approx. 30 x 13 x 43 cm. B6 695 5032  
\$199.95

**5 UMBRELLA**  
See p. 14



1-2

**1 MEN'S SOFTSHELL JACKET<sup>1</sup>**

Black/grey blend. 100% polyester. Wind- and water-repellent. High-closing collar. Width- and size-adjustable hood with zipper. Width-adjustable hem. Width-adjustable sleeve end with inside cuffs with thumb hole. Strap for headphones cable. Modern fit. Sizes: S-XXL. B6 695 8696-8700 \$265.95

**2 MEN'S WINTER PARKA**

Black. Outer material and padding 100% polyester, taffeta lining 100% nylon. Water- and wind-resistant. 2-way front zip closing. Detachable width- and size-adjustable hood. Adjustable hem. Adjustable cuffs. Various pockets. Size S-XXXL. B6 787 1177-1182 \$299.95



9

**9 MEN'S POLO SHIRT**

Dark red with navy contrasts. 65% cotton/35% polyester. Polo collar and cuffs with woven-in stripes and texture. Half-moon in fancy-flake yarn on the inside of the collar. Two-tone buttons, neck and side groove bands with detailed design from diamond radiator grille. Slim Fit. Sizes S-XXL. B6 695 8581-8585 \$116.95

**10 MEN'S T-SHIRT**

Black. 95% cotton/5% elastane. Slim-fit. Sizes S-XXL. B6 695 8319-8323 \$52.95

**11 MEN'S T-SHIRT**

Navy with dark red contrasts. 95% viscose/5% polyester. Narrow crew neck in single rib. Sleeves with a turnover fold. Taped chest pocket. Contrasting topstitching in multi-coloured thread on the back and on the seam. Slim-fit. Sizes S-XXL. B6 695 8586-8590 \$107.95

**12 MEN'S T-SHIRT**

100% Supima cotton. Short V-neck. Tonal neck band with silver grey stripe. Modern fit. Sizes: XS-XXL.

White B6 695 8722-8727

Black (not shown) B6 695 8716-8721 \$40.95

**13 LADIES' BLOUSE-STYLE SHIRT**

Black. Front section 75% viscose/25% silk, sleeves and back 100% viscose. Short sleeves. Side vents. Modern fit. Tonal, embroidered Mercedes star on the left upper arm. Sizes XS-XL. B6 695 8661-8665 \$151.95



10-12

**14 LADIES' JACKET**

Black/gold-coloured. Outer material 100% polyester, taffeta lining 55% polyester/45% viscose. Sewn-on pockets. Zipped chest pockets. Drawcord for adjustable waist width. Elastic ribbed inserts around the waist. Stand-up collar and cuffs with single rib. Modern fit. Embroidered, tonal Mercedes star on circular badge on the left sleeve. Black band with woven, golden identity pattern on the inside at the drawstring around the waist. Sizes XS-XL. B6 695 8656-8660 \$267.95

**15 LIFESTYLE SUNGLASSES**

Brown-blue transparent acetate frame. Grey lenses by Carl Zeiss Vision. 100% UV-A/UV-B protection (UV-400). Filter category 3. Anti-reflective coating. B6 695 3501 \$173.95

**16 WOMEN'S LIFESTYLE SUNGLASSES**

Gold-coloured stainless steel version with Havana brown acetate glass enclosure and navy blue acetate earpieces. Brown lenses by Carl Zeiss Vision. 100% UV-A/UV-B protection (UV-400). Filter category 3. Anti-reflective coating. B6 695 3488 \$173.95



13-14

**3 MENS JACKET**

Black. 100% polyester. Water-repellent. Chin guard. Width adjustable at lower edge. Loop for earphone cable inside. Various pockets. Sizes S-XXL. B6 695 8399-8403 \$183.95

**4 MEN'S JACKET**

Navy. 100% polyester. Design details from the diamond radiator grille. Wind-resistant. High-closing collar. Removable and stowable hood. Various pockets. Modern fit. Sizes S-XXL. B6 695 8576-8580 \$266.95

**5 FLAT BRIM CAP**

Black. Underside of brim in silver grey. 80% polyacrylic/20% wool. 6-panel. Adjustable fit. B6 695 3170 \$35.95

**6 CAP**

Black. Cotton. Adjustable fit. B6 695 4531 \$25.95

**7 LADIES' CAP**

Black. 100% cotton. Brushed cotton outer material. Adjustable fit. B6 695 4533 \$30.95

**8 CAP**

Anthracite. Polyester. Water-repellent outer material, perforated Mercedes star. Adjustable fit. B6 695 4291 \$63.95



3-4



5-8

<sup>1</sup> Available from June 2019.



15-16

All products on this page

TOMMY HILFIGER



1

### 3 MEN'S GILET<sup>1</sup>

Grey blend. 84% polyester/16% viscose. Lining and wadding: 100% polyester. Knitted collar with catch and press stud fastener. Front zip fastening. Seam and cuffs with textured knit and embroidered stripes. Zipped, angled side pockets. Zipped inner pocket. By Tommy Hilfiger for Mercedes-Benz. Sizes: S-XXL. B6 695 8823-8827 \$312.95



3

### 1 MEN'S JACKET<sup>1</sup>

Navy. Outer material: 93% new wool/7% polyurethane, inner lining mesh/taffeta lining: 100% polyester. Seam and cuffs with textured knit. Knitted collar with catch and press stud fastener. Front zipper fastening. Zipped, angled side pockets. Zipped inner pocket. Slim fit. By Tommy Hilfiger for Mercedes-Benz. Sizes: S-XXL. B6 695 8818-8822 \$475.95



2

### 2 MEN'S POLO SHIRT<sup>1</sup>

100% cotton piqué with cooling accoutrements (ClimaCool) Single rib collar and cuffs. Side vents. Drop-tail cut Slim fit. By Tommy Hilfiger for Mercedes-Benz. Sizes S-XXL.

Red B6 695 8813-8817

White (not shown) B6 695 8808-8812

\$127.95



4-5

### 4 MEN'S SWEAT HOODY<sup>1</sup>

Navy. 89% cotton/11% polyester. Hood with drawstring and striped cord ends. Corded neck ribbon with woven stripes. Front kangaroo pocket. Sleeve and hem rounded off with single rib with embroidered stripes. Slim fit. By Tommy Hilfiger for Mercedes-Benz. Sizes: S-XXL. B6 695 8803-8807 \$203.95

### 5 MEN'S SWEAT PANTS<sup>1</sup>

Navy. 89% cotton/11% polyester. Elastic seam with drawstring and striped cord ends. Hem rounded off with single rib with embroidered stripes. Slim fit. By Tommy Hilfiger for Mercedes-Benz. Sizes: S-XXL. B6 695 8828-8832 \$189.95

All products on this page

TOMMY HILFIGER

<sup>1</sup> Available from April 2019.



**1 SHOPPING BAG**  
 Imitation leather. Removable inside zip pocket.  
 Press-stud fastening.  
 Dimensions approx. 36 x 15 x 35 cm.  
**Red/gold-coloured** B6 695 3713  
**Blue/silver-coloured** (not shown) B6 695 3714  
**Silver-coloured/black** (not shown) B6 695 3712  
 \$71.95

**2 CREDIT CARD WALLET**  
 Black. Cowhide. Various compartments.  
 RFID protection. Mercedes star embossing.  
 Dimensions approx. 12 x 2 x 9 cm.  
 B6 695 3719  
 \$75.95



**BREE**  
 SINCE 1970

**3 CROSS-BODY BAG**  
 Black. Cowhide. Small inner compartment.  
 Adjustable carrier belt. Small buckle with  
 Mercedes star. By BREE for Mercedes-Benz.  
 Size approx. 19 x 6 x 13 cm. B6 695 4156  
 \$284.95

**4 LADIES' PURSE**  
 Greige. Cowhide. All-round metal zipper.  
 Various compartments for notes, coins and cards.  
 Dimensions approx. 11 x 11 cm. B6 695 5035  
 \$204.95

**5 LADIES' RUCKSACK**  
 Greige. Cowhide. Large main compartment with  
 inside pocket. Drawcord and additional toggle catch.  
 Adjustable shoulder straps. Mercedes-Benz  
 embossing on the inside pocket, Mercedes star stud  
 on cord stopper. Dimensions approx. 28 x 14.5 x 32 cm.  
 B6 695 5034  
 \$400.95



4-5

**6 MINI WALLET**  
 Black. Leather. RFID protection. Various note, coin,  
 card compartments and pockets. With embossed  
 Mercedes star. Dimensions approx. 10.5 x 2 x 7 cm.  
 B6 695 3718  
 \$52.95

**7 SHOPPING TOTE**  
 Grey. 100% polyester felt. Carrying handles in seat  
 belt material. Zipped inner pocket with snap hook.  
 Dimensions approx. 26 x 14 x 40 cm. B6 695 2989  
 \$26.95

**8 SHOPPING TOTE**  
 Polyester. Genuine leather detail. Large main  
 compartment and various inner compartments.  
 Removable cosmetics bag. Mercedes-Benz  
 proprietary pattern stitching.  
 Dimensions approx. 51 x 22 x 34 cm.  
**Cherry tomato** B6 695 4704  
**Nebulus blue** (not shown) B6 695 4787  
 \$230.95



6



7



8



9-11

**9 HANDBAG**  
 Blue. Polyurethane. Various inside pockets.  
 Zipper pocket on back. With pulling strap and  
 small D-ring to attach the key ring. Mercedes  
 star embossing on front. By Fritzi aus Preußen  
 for Mercedes-Benz. Dimensions approx.  
 36 x 15 x 32 cm. B6 695 3729  
 \$231.95

**10 WALLET**  
 Blue. Polyurethane. Various compartments  
 for notes, coins and cards. By Fritzi aus  
 Preußen for Mercedes-Benz. Dimensions  
 approx. 19 x 3 x 11 cm. B6 695 3728  
 \$153.95

**11 LOVE KEY RING**  
 Blue/red. Leather/die-cast zinc. Flat split  
 ring with three mini split rings for quick  
 removal/replacement of individual keys.  
 Length approx. 14 cm. B6 695 3619  
 \$61.95

*Fritzi aus Preußen*  
 BAGS | SHOES | APPAREL





1

2

3

4

5

**LAMY**  
Design. Made in Germany.

eva solo

**1 WALLET**  
Black. Cowhide. RFID protection. Various compartments inside. Mercedes star embossing. Dimensions approx. 10x2x12 cm. B6 695 3717 \$87.95

**2 TO-GO CUP**  
Silver-coloured/black. Stainless steel. Double-walled. Functional drinking cap. Silicone wrist strap with raised, embossed Mercedes-Benz lettering. Laser-engraved Mercedes star. By eva solo for Mercedes-Benz.

Diameter approx. 6.5 cm, height approx. 20 cm. Capacity approx. 0.35 l. B6 695 5013 \$66.95

Diameter approx. 7.5 cm, height approx. 20 cm. Capacity approx. 0.5 l. B6 695 5014 \$85.95

**3 A-CLASS KEY RING**  
See p. 13

**4 LAMY LOGO BALLPOINT PEN**  
Barrel in Mercedes-Benz paintwork colour. Plastic/stainless steel. Push-action. Takes LAMY M 16 large-capacity refills. Silver-coloured Mercedes-Benz logo print on barrel. In decorative test tube packaging. By LAMY for Mercedes-Benz. Made in Germany.

**Cosmos black, blue ink** B6 695 4239 \$26.95

**5 CASUAL SUNGLASSES**  
Black/transparent acetate frame. Lenses with grey colour gradient by Carl Zeiss Vision. 100% UV-A/UV-B protection (UV-400). Filter category 3. B6 695 3487 \$251.95



6



7-8

**6 EQ KEY RING<sup>1</sup>**  
Silver/black/blue. Stainless steel/plastic. "Coming Home" function. Key ring with special, easy-to-open lock. Three additional mini split rings for quick removal/replacement of individual keys. Length approx. 9 cm. B6 695 3963 \$145.95

**7 TYPO EQC KEY RING**  
Silver-coloured/black/blue. Stainless steel/luminous material. Front features replica of original lettering on rear of vehicle, back features 3D star logo. Flat split ring with three additional mini split rings for quick removal/replacement of individual keys. Designed in Germany. Length approx. 9 cm. B6 695 3962 \$97.95



9-10



11

**8 TYPO KEYCHAIN**  
Black/silver-coloured. Stainless steel. Flat keyring with 3 smaller split rings for quick removal/replacement of individual keys. Front features replica of original lettering on rear of vehicle, back features 3D star logo. Designed in Germany. Length approx. 9 cm.

- A-Class (p. 12) B6 695 8414
- B-Class (not shown) B6 695 8415
- C-Class (not shown) B6 695 8416
- E-Class (not shown) B6 695 8417
- G-Class (not shown) B6 695 8418
- S-Class (not shown) B6 695 8419
- V-Class (not shown) B6 695 8420
- X-Class (not shown) B6 695 3618
- SL B6 695 8421
- CLA (not shown) B6 695 8422
- CLS (not shown) B6 695 8423
- GLA (not shown) B6 695 8424
- GLC (not shown) B6 695 8425
- GLE (not shown) B6 695 8426
- GLS (not shown) B6 695 8427
- SLC (not shown) B6 695 8428

**9 MYFLAVOUR DRINKING BOTTLE, 0.75 L**  
Transparent/silver. Tritan. Skewer for fruits. Practical carrying loop. Dishwasher safe. Laser-engraved Mercedes-Benz star. By eva solo for Mercedes-Benz. Diameter approx. 7.5 cm, height approx. 25.5 cm. Capacity approx. 0.75 l. B6 695 5015 \$56.95

**11 LAMY LOGO BALLPOINT PEN**  
See p. 12  
**Hyacinth red, blue ink** B6 695 4238  
**Denim blue, blue ink** (not shown) B6 695 3419  
**Diamond white, black ink** (not shown) B6 695 3087  
**Mountain grey, black ink** (not shown) B6 695 3652 \$26.95

**12 CRYSTAL PENCILS, SET-OF-5**  
Black. Wood/glass. Writes in black. One Swarovski® crystal in either white, blue, green, red or black respectively on the front of the pencil. Made for Mercedes-Benz by Swarovski®. Length approx. 17.5 cm. B6 695 4467 \$29.95



12

**10 TO GO TEA MUG, 0.35 L**  
Black. Stainless steel. Double-walled. Functional drinking cap with brewing unit. Silicone wrist strap with raised, embossed Mercedes-Benz lettering. Laser-engraved Mercedes star. By eva solo for Mercedes-Benz. Diameter approx. 7.5 cm, height approx. 17.5 cm. Capacity approx. 0.35 l. B6 695 5083 \$113.95

<sup>1</sup> Available from June 2019.



1

**1 CONVENTIONAL UMBRELLA, STRETCH**  
Steel shaft. Plastic hook handle. Fibreglass rails. Windproof design. Automatic guest umbrella with automatic extension of canopy on all sections. Tonal Mercedes star print, hook handle with star badge. Length approx. 82 cm. Diameter when open approx. 130 cm.  
**Red/orange** B6 695 4814  
**Orange/yellow** B6 695 4815  
**Petrol/mint** B6 695 4816  
**Purple/lilac** B6 695 4817  
\$72.95



2

**2 GUEST UMBRELLA**  
Black. Water and dirt-repellent canopy. Aluminium shaft. Windproof. Automatic opening. Diameter when open approx. 130 cm. B6 695 2630  
\$88.95



3

**3 COMPACT UMBRELLA**  
Black. Water and dirt-repellent canopy. Chromed steel shaft. Windproof. Automatic opening and closing. Length approx. 30 cm, diameter when open approx. 97 cm. B6 695 2631  
\$70.95

**4 UMBRELLA**  
Transparent/black. Aluminium/polyethylene. Special-coated plastic handle. Automatic opening. Fastening tab with Velcro fastener. Windproof. Inset star badge in the handle. Diameter when open approx. 105 cm. B6 695 4529  
\$69.95

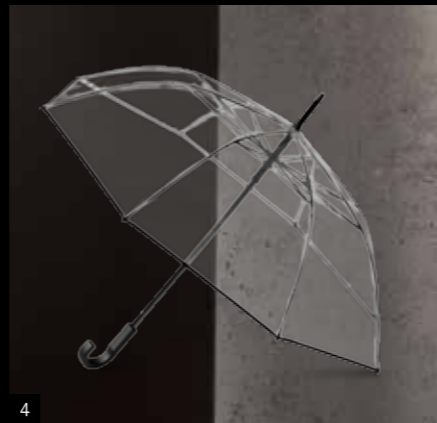

4



5

**5 UMBRELLA**  
Black. Water and dirt-repellent canopy. Aluminium shaft. Windproof. Automatic opening. Diameter when open approx. 105 cm. B6 695 2629  
\$52.95

**6 COVER FOR iPhone® 7/iPhone® 8**  
White/silver-coloured. Plastic/aluminium. Wireless charging function is not supported. B6 695 3560  
\$57.95

**7 COVER FOR iPhone® 7/iPhone® 8**  
In alubeam silver. Plastic. Wireless charging function is not supported. B6 695 3561  
\$57.95

**8 BOOK-TYPE COVER**  
Polycarbonate/cowhide. Fashionable stitching. Apertures for camera, buttons and connections. 3D Mercedes star. Suitable for NFC tags and wireless charging.

**iPhone® X/iPhone® XS**  
**Black** (not shown) B6 695 8598  
**Blue** (not shown) B6 695 8599  
**iPhone® 7/iPhone® 8**  
**Black** B6 695 8614  
**Blue** (not shown) B6 695 8616

**Samsung Galaxy S8**  
**Black** (not shown) B6 695 8606  
**Blue** (not shown) B6 695 8607  
\$133.95

**iPhone® 7 PLUS/iPhone® 8 PLUS**  
**Black** (not shown) B6 695 8615  
**Blue** (not shown) B6 695 8617  
\$147.95

**9 CASE FOR SAMSUNG GALAXY S8**  
Black. Polycarbonate. Soft-touch material. Aperture for camera, control buttons and connections. 3D star. Suitable for wireless charging. B6 695 3799  
\$35.95

**10 COVER FOR iPhone® 7/iPhone® 8**  
Plastic. Suitable for wireless charging.  
**Black** B6 695 3239  
**White** (not shown) B6 695 3240  
\$32.95



6-7



8

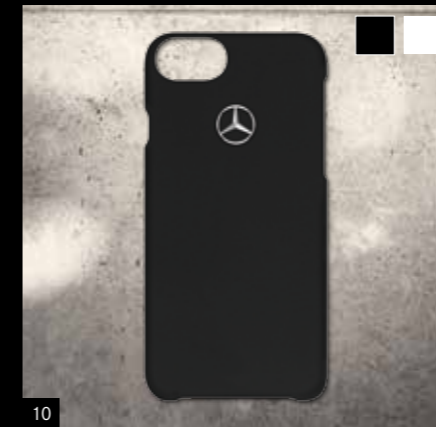

10



9



11



12

**11 COVER**  
Black. Polycarbonate/microfibre. Apertures for camera, buttons and connections. 3D Mercedes star. Suitable for wireless charging.  
**iPhone® X/iPhone® XS** B6 695 3638  
\$35.95  
**iPhone® XR** (not shown) B6 695 5205  
\$40.95

**12 COVER**  
Polycarbonate/cowhide. Apertures for camera, buttons and connections. Suitable for NFC tags and wireless charging.  
**iPhone® X/iPhone® XS**  
**Black** (not shown) B6 695 8600  
**Blue** (not shown) B6 695 8602  
**Grey** (not shown) B6 695 8601  
\$61.95

**iPhone® 7 Plus/iPhone® 8 Plus**  
**Black** (not shown) B6 695 8619  
**Blue** (not shown) B6 695 8621  
**Grey** (not shown) B6 695 8623  
\$98.95  
**iPhone® 7/iPhone® 8**  
**Black** (not shown) B6 695 8618  
**Blue** (not shown) B6 695 8620  
**Grey** (not shown) B6 695 8622  
\$61.95

**Samsung Galaxy S8**  
**Black** (not shown) B6 695 8603  
**Blue** (not shown) B6 695 8604  
**Grey** B6 695 8605  
\$61.95



#### 5 CAPE TOWN KEY RING

Black/silver-coloured. Stainless steel. Snap hook with three mini split rings for quick removal/replacement of individual keys. Design based on the Mercedes-Benz radiator grille. Length approx. 5.5 cm. B6 695 6711 \$59.95

#### 6 PRAGUE KEY RING

Rose gold colours. Stainless steel/mother-of-pearl/PVD coated. Link chain. Key ring with special, easy-to-open lock. Three additional mini split rings for quick removal/replacement of individual keys. Length approx. 10 cm. B6 695 3744 \$145.95



#### 1 BILBAO KEY RING

Black/silver. Leather/stainless steel. Flat split ring with three additional mini split rings for quick removal/replacement of individual keys. Length approx. 12 cm. B6 695 3823 \$72.95

#### 2 LAS VEGAS KEY RING

Silver-coloured/black. Stainless steel. Luminous finish in the inner contours. Flat split ring with three mini split rings for quick removal/replacement of individual keys. Length approx. 9 cm. B6 695 8326 \$95.95

#### 3 BRUSSELS KEY RING

Die-cast zinc with high-sheen polished finish. Rotating Mercedes star. Flat keyring with 3 smaller split rings for quick removal/replacement of individual keys. Length approx. 9 cm.

**Silver-coloured** B6 695 7516

\$18.95

**Gold-coloured** (not shown) B6 695 3741

\$21.95

#### 4 UNTERTÜRKHEIM KEY RING

Black/silver-coloured. Stainless steel. Flat split ring with three mini split rings for quick removal/replacement of individual keys. Made in Germany. Length approx. 7 cm. B6 695 3307 \$45.95



#### 7 TOKYO BRACELET

Glass/stainless steel. Made for Mercedes-Benz by Swarovski®. Length approx. 41.5 cm.

**Red/silver-coloured** B6 695 4719

**Black/silver-coloured** (not shown) B6 695 4718 \$153.95

#### 8 TOKYO KEY RING

Stainless steel. Adorned with Swarovski® crystals. Flat keyring with 3 smaller split rings for quick removal/replacement of individual keys. Made for Mercedes-Benz by Swarovski®. Length approx. 9 cm.

**Black/silver-coloured** B6 695 4716

**Red/silver-coloured** (not shown) B6 695 4717

\$116.95

#### 9 ST. TROPEZ KEY RING

Stainless steel. Background adorned with Swarovski® Crystal Fine Rocks. Flat keyring with 3 smaller split rings for quick removal/replacement of individual keys. Length approx. 9 cm.

**Silver-coloured/red** B6 695 9999

**Silver-coloured/black** (not shown) B6 695 2740

**Silver-coloured/blue** (not shown) B6 695 3429

**Silver-coloured/white** (not shown) B6 695 9998 \$97.95



#### 10 DOG'S CUSHION, BY MIACARA®

Grey. Polyester/polyurethane. Cover can be removed and washed.

Made for Mercedes-Benz by MiaCara®. Sizes S-L.

**Size S** B6 695 8838 \$282.95

**Size M** B6 695 8839 \$370.95

**Size L** B6 695 8840 \$459.95

#### 11 DOG COLLAR, BY MIACARA®

Grey. Leather/stainless steel. Buckle. Made in Italy.

Made for Mercedes-Benz by MiaCara®. Sizes S-L. B6 695 8833-8835

\$176.95

#### 12 DOG LEASH, BY MIACARA®

Grey. Saffiano leather. Adjustable to two lengths with snap hook.

Mercedes star stitching on lower end. Made in Italy. Made for Mercedes-Benz

by MiaCara®. Total length approx. 1.95 m. B6 695 8836

\$229.95



# Mercedes-Benz Select.

The new fragrance for men.



Mercedes-Benz

**1 MERCEDES-BENZ PERFUME SELECT**  
 Eau de toilette. Men's fragrance.  
**Contents approx. 50 ml** (illustration p. 18)  
 B6 695 8767  
 \$109.95  
**Contents approx. 100 ml** (not shown)  
 B6 695 8766  
 \$144.95

**2 MERCEDES-BENZ WOMEN'S PERFUME**  
 Eau de toilette. Ladies' fragrance. Atomiser.  
**Contents approx. 30 ml** (not shown) B6 695 8770  
 \$90.95  
**Contents approx. 60 ml** B6 695 8769  
 \$118.95

**3 MERCEDES-BENZ ROSE PERFUME**  
 Eau de toilette. Ladies' fragrance. Atomiser.  
**Contents approx. 30 ml** B6 695 8574  
 \$83.95  
**Contents approx. 60 ml** (not shown) B6 695 8573  
 \$103.95



**4 MERCEDES-BENZ MEN'S PERFUME**  
 Eau de toilette. Men's fragrance. Atomiser.  
**Contents approx. 40 ml**  
 B6 695 8372  
 \$78.95  
**Contents approx. 75 ml** (not shown)  
 B6 695 8225  
 \$90.95

**5 MERCEDES-BENZ COLOGNE PERFUME**  
 Eau de toilette. Men's fragrance. Atomiser.  
**Contents approx. 40 ml** (not shown)  
 B6 695 8571  
 \$83.95  
**Contents approx. 75 ml**  
 B6 695 8570  
 \$92.95

**7 MERCEDES-BENZ LE PARFUM PERFUME**  
 Eau de parfum. Cologne. Atomiser.  
**Contents approx. 120 ml** B6 695 8568  
 \$144.95

**6 MERCEDES-BENZ MEN'S PERFUME**  
 Eau de toilette. Men's fragrance. Atomiser.  
**Contents approx. 50 ml** (not shown)  
 B6 695 8631  
 \$114.95  
**Contents approx. 100 ml**  
 B6 695 8630  
 \$139.95



USE THE WALLET FUNCTION OF YOUR SMARTPHONE

Simply scan the QR code and you will have the opportunity to clearly store the high-quality personal accessories from the Mercedes-Benz Collection on your mobile phone. Once stored, you are always up to date, wherever you are.



**1 WOMEN'S WRISTWATCH, ELEGANT**

Stainless steel case with rose gold-coloured PVD coating. Mother-of-pearl dial. Rose gold-coloured hands with Super-LumiNova® detail. Anti-reflective mineral glass on both sides. Beige leather strap, black paintwork on the cut edges. Diameter 35 mm. Ronda 702 quartz movement. B6 695 4184 \$216.95

**2 MEN'S WRISTWATCH, ELEGANT**

Stainless steel case. Brilliant blue dial. Steel-coloured hour and minute hands, red second hand, tips with Super-LumiNova® detail, four double indices. Anti-reflective mineral glass on both sides. Black calfskin strap. Water-resistant to 10 ATM. Diameter 40 mm. Ronda 513 quartz movement. B6 695 4177 \$216.95

**5 WOMEN'S SPORT FASHION CHRONOGRAPH M3**

Stainless steel case with rose gold-coloured PVD and white ceramic bezel. White dial with pink gold-coloured applications. Rose gold-coloured hands with Super-LumiNova® detail. Swarovski® crystals as hour markers. Anti-reflective mineral glass on both sides. White calfskin strap. Water-resistant to 10 ATM. Diameter 39 mm. Ronda 5030 quartz movement. Swiss made. B6 695 4170 \$415.95

**6 LADIES' WATCH, GLAMOUR**

Silver/black. Stainless steel case. Black dial with eight Swarovski® crystals as hour markers and black Swarovski® Crystal Fine Rocks in centre. Silver-coloured luminous hands. Mineral crystal. Black calfskin wristband. Water-resistant to 5 ATM. Diameter 37 mm. Miyota GM10 quartz movement. B6 604 1922 \$211.95



1-2

**3 SMARTWATCH, GARMIN VIVOACTIVE 3**

Plastic/stainless steel/silicone. Colour touchscreen display. Mercedes-Benz branding on back of case, inside of strap and pushbutton. Dials fashioned exclusively in Mercedes-Benz design. Compatible with Android and Apple. Battery life GPS mode approx. 13 hours, smartwatch mode up to 7 days. Measurement of vital signs and stress levels, suggestions for activation of vitality and relaxation programmes. Garmin Pay™ support. Compatible with Garmin Connect™ mobile app. Water-resistant to 5 ATM. Diameter 43.4 mm.

Installed language settings:

**Black** B6 695 8847, **white** B6 695 8853: Danish, Dutch, Finnish, English (US), French (FR), Italian, German, Norwegian, Spanish, Swedish, Portuguese (BZL), Portuguese (PT)

**Black** B6 695 8848, **white** B6 695 8854: English (US), Russian, Czech, Hungarian, Polish, Slovakian, Hebrew

**Black** B6 695 8849, **white** B6 695 8855: English (US), Greek, Arabic, Turkish, Croatian, Slovenian

**Black** B6 695 8850, **white** B6 695 8856: Simplified Chinese, English (US)

**Black** B6 695 8851, **white** B6 695 8857: Japanese, English (US)

**Black** B6 695 8852, **white** B6 695 8858: Korean, English (US) \$429.95



3

**4 WALL CLOCK**

Silver-coloured. Aluminium dial and case. Black numerals. Quartz movement. Thermometer and hygrometer function. Diameter approx. 30 cm. B6 787 0476 \$52.95



4



6

5



7

**7 WOMEN'S FASHION GOLD WRISTWATCH**

Stainless steel case with gold-coloured PVD coating. Blue dial trimmed with six Swarovski® crystals. Blue leather/textile strap. Yellow/gold-coloured hands. Water-resistant to 5 ATM. Diameter approx. 35.5 mm. Ronda 1002 Swiss movement. Swiss movt. B6 695 3564 \$478.95

20

21



**MEN'S SUNGLASSES, BUSINESS**

Anthracite-coloured stainless steel version with black acetate earpieces. Hardened lenses with grey colour gradient and with ANTI-REFLECTION coating by Carl Zeiss Vision. 100% UV-A/UV-B protection (UV-400). Filter category 3. B6 695 3486 \$389.95

**BUSINESS BAG**

Black. Leather/nylon. Two large main compartments, various inner and side compartments. Detachable, adjustable shoulder belt. Strap at back for slotting over towbar of trolley suitcase. By BREE for Mercedes-Benz. Dimensions approx. 41 x 11 x 30.5 cm. B6 695 2885 \$402.95



# Business class.

Our collection for your professional life is distinctively characterised by Mercedes-Benz style. Carefully manufactured pens, discreet jewellery as well as stylish chronograph watches are characterised by the finest materials and finishes. Each of the items perfectly tailored to your everyday working life receive their finishing touches by their use in your private life.

**MEN'S FUNCTIONAL COAT**

Silver-grey, 100% polyamide outer material, 100% polyester inner lining. Bonded inner seams. Hood with zipper. Concealed snap fastening. Side flap and water-resistant zipped pockets. Zipped breast pocket with outlet for headphones cable. Width-adjustable sleeves. Modern fit. Sizes: S-XXL. B6 695 8681-8685 \$673.95

**MEN'S MERCEDES-BENZ AUTOMATIC WRISTWATCH**

Stainless steel case with polished and matte finish. Black dial with blue minute markers. Silver-coloured hands and indices with Super-LumiNova® detail.

Anti-reflective sapphire glass on both sides. Stainless steel strap with polished and matte finish. Date feature. Water-resistant to 10 ATM. Diameter 43 mm. ETA 2824 automatic movement. Swiss made. B6 695 3968 \$1,329.95

**MEN'S BELT**

Black. Italian calfskin. Adjustable fit. Length approx. 125 cm, width approx. 3.4 cm. B6 695 3047 \$142.95

**MEN'S POLO PULLOVER**

See p. 27



**BREE**  
SINCE 1970

**THE MERCEDES-BENZ COLLECTION**



### 1 LAPTOP BAG

Black. Polyester/nylon/polyurethane. Large main compartment with removable laptop compartment for laptops up to approx. 40.6 cm (16 inches). Expandable front compartment with tablet compartment and space for documents. Outer compartment with practical partitioning. Two carrying handles. Detachable shoulder strap. Smart sleeve for secure transport on top of suitcase. By Samsonite for Mercedes-Benz. Dimensions approx. 45x16/19x33 cm. Capacity approx. 18/21.5 l. Weight: approx. 1.1 kg. B6 695 8844 \$191.95



### 2 PILOT SUITCASE

Black. Polyester/nylon/polyurethane. Large main compartment with padded laptop compartment for laptops up to approx. 43.9 cm (17.3 inches), tablet compartment and separate compartment with packing straps for clothing or documents. Zipped outside pocket and practical partitioning. Two robust double rollers. Cabin-ready dimensions. By Samsonite for Mercedes-Benz. Dimensions approx. 48x22x40 cm. Capacity approx. 32 l. Weighs approx. 3 kg. B6 695 8845 \$309.95

### 3 WASH BAG

Black. Polyester/nylon/polyurethane. Main compartment with various internal pockets. Small zipped outer compartment. Hook for hanging. By Samsonite for Mercedes-Benz. Dimensions approx. 25x11x23 cm. Capacity approx. 6 l. Weight: approx. 0.3 kg. B6 695 8846 \$117.95



All products on this page

**Samsonite**

### 4 X'BLADE SUITCASE

Black. Polyester/nylon/polyurethane. Large main compartment with compression packing belt. Three zipped outer compartments. Wet pocket on the inside of the lid. TSA lock. Double rollers. With additional bag. Cabin-ready dimensions. By Samsonite for Mercedes-Benz.

#### X'BLADE 71 SUITCASE

Dimensions approx. 45x29/34x71 cm, volume approx. 88 l/95 l, weight approx. 3.4 kg. B6 695 8843 \$428.95

#### X'BLADE 63 SUITCASE

Dimensions approx. 42x27/31x63 cm, volume approx. 66 l/72 l, weight approx. 2.8 kg. B6 695 8842 \$390.95

#### X'BLADE 55 SUITCASE<sup>1</sup>

Dimensions approx. 40x20x55 cm, volume approx. 41 l, weight approx. 2.5 kg. Suitable as cabin luggage. B6 695 8841 \$352.95

<sup>1</sup> Not necessarily applicable with all airlines. Please check the individual airline's hand luggage restrictions.

**1 LAUREL LEAF LAPEL PIN**

Stainless steel. The motif adorns the laurel leaf badge found on Mercedes-Benz passenger car model series. Butterfly clasp and anti-twist lock on back. Diameter approx. 1 cm. B6 695 3551 \$28.95

**2 MERCEDES STAR LAPEL PIN**

Polished stainless steel. Butterfly clasp and anti-twist lock on back. Diameter approx. 1 cm. B6 695 3080 \$18.95



1-2



3

**3 GUEST UMBRELLA<sup>1</sup>**

Black, 100% polyester canopy. Aluminium shaft. Fibreglass ribs. Two-piece exclusive handle. Automatic opening. Water and dirt-repellent coating. Windproof. Diameter when open approx. 120 cm. B6 695 4412 \$181.95

**4 MEN'S BUSINESS CHRONOGRAPH WATCH**

Stainless steel case, with part black PVD coating. Black dial with sunray embossing in the counter eyes and steel-coloured hour markers with Super-LumiNova® luminous detail. Luminous hands. Water-resistant to 10 ATM. Diameter approx. 42 mm. Ronda 5030 Swiss quartz movement. Swiss made. B6 695 3530 \$699.95



5



6

**5 RUCKSACK<sup>1</sup>**

Black. Polyester/cowhide details. Various compartments on inside and outside. 2-way zip fastening. Trolley connection system. Can be used as a rucksack and bag. Padded rear. Mercedes star stud. Dimensions approx. 40.5 x 15 x 30.5 cm. B6 695 4122 \$231.95

**6 PAPERWEIGHT**

Silver shadow/chrome/black. Die-cast zinc. All-round chromed plastic clasp. Base underside with foam rubber coating. Original radiator grille star from the vehicle. Mercedes-Benz form language designed in Germany. Dimensions approx. 13 x 13 x 13 cm. B6 695 4610 \$201.95



4



7-8

**7 MEN'S POLO SHIRT**

Light grey blend/dark green. 100% mercerised cotton. Single-rib, knitted pattern collar and cuffs featuring contrasting stripes. Woven neckband with identity pattern. Modern fit. Sizes S-XXL. B6 695 8686-8690 \$168.95

**8 MEN'S POLO PULLOVER**

Dark grey blend. 100% merino wool. Collar, seam and cuffs with single rib. Modern fit. Sizes: S-XXL. B6 695 8691-8695 \$218.95

**9 MEN'S BELT**

Brown. 100% leather. Adjustable fit. Length approx. 125 cm. Width approx. 3,4 cm. B6 695 4117 \$142.95



9

**10 BUSINESS CARD WALLET**

Black. Italian calfskin. Various compartments inside, plus pocket on back. Suitable for bank cards, credit cards, business cards or loyalty cards, up to 9 x 6 cm. Dimensions approx. 11 x 1.5 x 7.5 cm. B6 695 2884 \$65.95



10

**11 MINI CREDIT CARD WALLET**

Black. Italian calfskin. 3 slots for approx. 6 cards. Dimensions approx. 10 x 0.6 x 7.5 cm. B6 695 1619 \$73.95



11

**12 CREDIT CARD WALLET WITH MONEY CLIP**

Black. Calfskin. RFID protection. Eight credit card slots. Mercedes star stud. Dimensions approx. 11 x 1 x 9 cm. B6 695 3959 \$196.95



12

**13 WALLET**

Black. Calfskin. RFID protection. Various compartments for notes, coins and cards. Mercedes star stud. Dimensions approx. 12.5 x 2 x 10 cm. B6 695 3960 \$196.95



13

**14 I-CLIP THE WALLET**

Black with silver-coloured details. Plastic/cowhide. Patented card system. For up to 12 cards. Money clip. Made in Germany. Dimensions approx. 8.7 x 6 x 1.6 cm. B6 695 4769 \$72.95



14

I-CLIP THE WALLET

<sup>1</sup> Available from May 2019.





**1 POWERBANK, 5,000 MAH**  
 Black/silver-coloured. Plastic. Capacity of 5,000 mAh. Two USB ports. Lithium-polymer battery. On/Off switch. Four LEDs for displaying the charge progress. With micro USB cable. Dimensions approx. 11 x 1.5 x 6.6 cm. B6 695 3522 \$107.95

1

28



2



3



4

**2 COVER FOR SAMSUNG GALAXY S8 BOOKTYPE**

Black. Polycarbonate/cowhide. Aperture for camera, control buttons and connections. 3D star. Suitable for wireless charging. B6 695 3798 \$104.95

**3 COVER FOR iPhone® 7/iPhone® 8**

Black. Plastic/cowhide. Suitable for wireless charging. B6 695 4094 \$57.95

**4 iPhone® 7 PLUS/iPhone® 8 PLUS COVER**

Black. Plastic/cowhide. Aperture for camera, control buttons and connections. 3D star. Suitable for wireless charging. B6 695 4139 \$71.95



5



Lanybook®

29

6



**LAMY**  
 Design. Made in Germany.

8



**LAMY**  
 Design. Made in Germany.

7



9



**5 LANYBOOK, LARGE**  
 See p. 30

**6 LAMY STUDIO FOUNTAIN PEN**

Black. Stainless steel. Writes in blue. Refillable. Shiny black Mercedes-Benz lettering on the shaft below the clip. By LAMY for Mercedes-Benz. B6 695 4774 \$195.95

**7 MOSCOW KEY RING**

Black/silver. Leather/stainless steel. Embossed leather key ring with crocodile grain. Flat split ring with three additional mini split rings for quick removal/replacement of individual keys. Length approx. 10 cm. B6 695 3743 \$127.95

**8 LAMY STUDIO BALLPOINT PEN**

Black. Stainless steel. Writes in black. Twist-action. Refillable. Shiny black Mercedes-Benz lettering on the shaft below the clip. By LAMY for Mercedes-Benz. B6 695 4773 \$152.95

**9 USB FLASH DRIVE, GEN. 6. 32 GB, USB 3.0**

In the shape of Mercedes-Benz Gen 6 vehicle key. 32 GB. USB 3.0 interface. Compatible with all standard operating systems. Dimensions approx. 3 x 1.4 x 6 cm.

**White/silver-coloured**  
 B6 695 4738

**Black/silver-coloured**  
 (not shown) B6 695 4737 \$72.95

### 1 LANYBOOK

Black. FSC paper®. 192 pages. Thread binding. Grey bookmark. Elastic pen loop. 3D star as Lanybutton, embossed Mercedes-Benz lettering on cover.

**Small.** Dimensions approx. 14 x 2 x 9 cm.  
B6 695 3636  
\$46.95

**Large** (Illustration p. 29). Inner compartment with rear overlap. Dimensions approx. 24.7 x 2 x 17.5 cm.  
B6 695 3637  
\$68.95

### 2 ST. PETERSBURG KEY RING

Silver-coloured/black. Stainless steel/leather. Flat split ring with three additional mini split rings for quick removal/replacement of individual keys. Made in Germany. Length approx. 9 cm.  
B6 695 3626  
\$103.95

### 3 KEY SLEEVE CASE

Cowhide. Aperture for Mercedes star. Embossed Mercedes-Benz lettering. Dimensions approx. 4.6 x 1.9 x 8 cm.

**White** B6 695 8413  
**Black** (not shown) B6 695 8412  
\$70.95

### 4 KEY CASE

Cowhide/stainless steel. Magnetic fastener. Carabiner keyring with 3 smaller split rings for quick removal/replacement of individual keys. Dimensions approx. 4.6 x 2.3 x 8.4 cm.

**White** B6 695 8409  
**Black** (not shown) B6 695 8408  
**Red** (not shown) B6 695 8410  
\$88.95  
**Carbon fibre leather (not shown)** B6 695 8411  
\$95.95

### 5 KEY CASE

Cowhide/stainless steel. Magnetic fastener. Flat keyring with 3 smaller split rings for quick removal/replacement of individual keys. Dimensions approx. 4.1 x 2.1 x 8.3 cm.

**White** B6 695 8405  
**Black** (not shown) B6 695 8404  
**Red** (not shown) B6 695 8406  
\$88.95  
**Carbon fibre leather (not shown)** B6 695 8407  
\$95.95



1

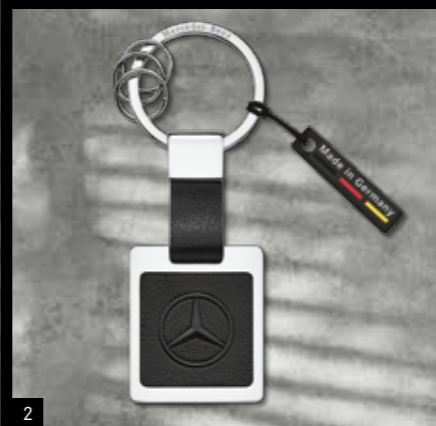

2



3

4-5



6

### 6 KEY WALLET

Black. Italian calfskin. Two leather straps with one large and one small split ring. With zipped compartment for small change on back. Dimensions approx. 11 x 2 x 7 cm. B6 695 2883  
\$65.95



7

**BREE**  
SINCE 1970

### 7 WALLET

Black. Cowhide. RFID protection. Various compartments for notes, coins and cards. Mercedes star stud. By BREE for Mercedes-Benz. Dimensions approx. 19 x 3 x 10 cm. B6 695 3734  
\$304.95



8

**BREE**  
SINCE 1970

### 8 HANDBAG

Black. Cowhide. Various compartments. Leather tag with Mercedes star. By BREE for Mercedes-Benz. Dimensions approx. 37 x 18 x 26 cm. B6 695 3733  
\$765.95



9

### 9 WOMEN'S WATCH, BUSINESS LADY

Stainless steel case. White dial with silver-coloured applications and Super-LumiNova® luminous dots. With date display and luminous hands. Water-resistant to 10 ATM. Diameter approx. 36.5 mm. Ronda 515 Swiss quartz movement. Swiss movt. B6 695 3532  
\$427.95



**3 WOMEN'S BUSINESS SUNGLASSES**  
Glossy gold frame with havanna-coloured acetate earpieces. Lenses with brown colour gradient, hardened and with ANTI-REFLECTION coating by Carl Zeiss Vision. 100% UV-A/UV-B protection (UV-400). Filter category 3.  
B6 695 3485  
\$389.95

**4 USB MEMORY STICK, 16GB, CRYSTAL**  
Rose gold/black. Plastic. Adorned with Swarovski® Crystal Ultrafine Rocks. 16 GB. USB 2.0 interface. Compatible with all standard operating systems. Made for Mercedes-Benz by Swarovski®. Dimensions approx. 4 x 3.6 x 1 cm.  
B6 695 4234  
\$114.95



**2 CRYSTAL KEY RING**  
Rose gold-coloured/black. Stainless steel/glass. Flat split ring with three additional mini split rings for quick removal/replacement of individual keys. Key ring with black Swarovski® Crystal Fine Rocks. Made for Mercedes-Benz by Swarovski®.  
Length approx. 8 cm.  
B6 695 3577  
\$154.95



**1 CRYSTAL DOG COLLAR**  
Black/rose gold-coloured. Cowhide/glass/stainless steel. Leather inlaid with Swarovski® Crystal Fine Rocks. Made for Mercedes-Benz by Swarovski®.  
**Small**  
Length adjustable from 28–36 cm. B6 695 3953  
**Large**  
Length adjustable from 48–56 cm. B6 695 3954  
\$190.95

**CRYSTAL JEWELLERY**  
Rose gold-coloured/black. Stainless steel/glass. Rounded off with Swarovski® crystal. Made for Mercedes-Benz by Swarovski®.

**5 CRYSTAL NECKLACE**  
With extension chain.  
Length approx. 50 cm. B6 695 3578  
\$169.95

**6 CRYSTAL BRACELET**  
Length approx. 15.7 cm  
B6 695 3584  
Length approx. 16.7 cm  
B6 695 3956  
\$169.95

**7 CRYSTAL RING**  
Size can be adapted by the jeweller.  
B6 695 3601  
\$133.95

**8 CRYSTAL NOTEBOOK**  
Black/rose gold-coloured. Cowhide/stainless steel/glass. High-quality fastener with Swarovski® Crystal Ultrafine Rocks. Inlay replaceable. Made for Mercedes-Benz by Swarovski®. Dimensions approx. 16.3 x 2.5 x 21.7 cm. B6 695 3602  
\$205.95



**MEN'S FUNCTIONAL SHIRT**

See p. 36

**MEN'S WINDCHEATER**

Green. 100% nylon. Mesh sections under the arms. Hood with drawcord. Zipper with chin guard. Two zipped pockets. Reflective elements for best visibility, windCELL technology. Performance fit. By PUMA for Mercedes-Benz. Sizes: S-XXL. B6 695 8783-8787 \$133.95

**MEN'S SHORTS**

Blue/green. 100% polyester. Flexible waistband with drawcord. Side pocket with zipper. Reflective imprints on front and back. By PUMA for Mercedes-Benz. Sizes: S-XXL. B6 695 8778-8782 \$57.95



# Athletic meets aesthetic.

Is it not sportiness that makes a Mercedes-Benz so unique? With the Mercedes-Benz Collection, we also pay tribute to this claim with fashion. Figure-accentuating cuts combined with materials that are as functional as they are beautiful exemplify pure athleticism – while exclusive details, such as the high-gloss Mercedes star or illuminating colours, exemplify unmistakable aesthetic appeal. Exclusive sports devices such as golf iron made from titanium round off the image in proper style.

All products on this page



SCAN THE QR CODE AND EXPERIENCE THE COLLECTION.

[http://mb4.me/MBA\\_Sport\\_Collection](http://mb4.me/MBA_Sport_Collection)

**THE MERCEDES-BENZ COLLECTION**



36

**MEN'S PERFORMANCE SHIRT**

Green. 100% polyester. Thermo-R technology, dryCELL technology wicks moisture perfectly away from the skin. Performance fit. By PUMA for Mercedes-Benz. Sizes: S-XXL. B6 695 8773-8777 \$71.95



1-2

**1 LADIES' WINDCHEATER**

Silver-coloured. 100% nylon. Mesh sections under the arms. Hood with drawcord. Adjustable waistline with drawcord. Water-repellant, windCELL technology. Laser cuts on the back for good ventilation. Performance fit. By PUMA for Mercedes-Benz. Sizes: XS-XXL. B6 695 8798-8802 \$142.95

**2 LADIES' PERFORMANCE SHIRT**

Peach colours. 100% polyester. Thermo-R technology, dryCELL technology wicks moisture perfectly away from the skin. Side mesh sections. Slim fit. By PUMA for Mercedes-Benz. Sizes XS-XL. B6 695 8788-8792 \$66.95

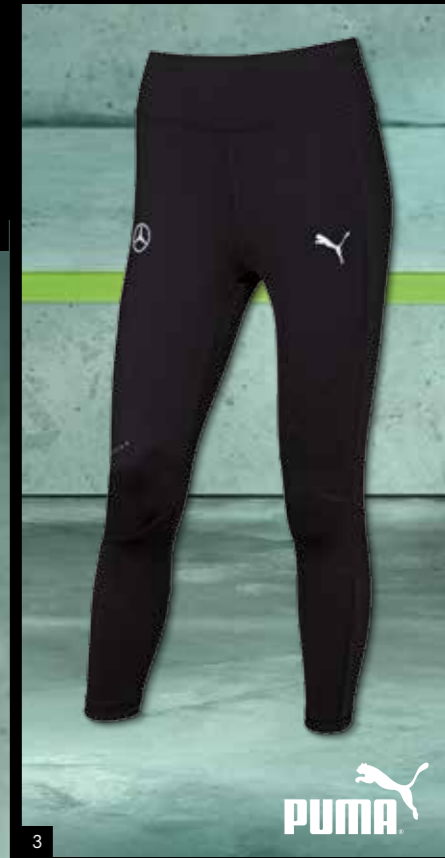

3

**3 LADIES' SPORTS PANTS**

Black. 77% polyester/23% elastane. 3/4 tight. Flexible waistband with drawcord. Pouch for valuables with zipper on the back. Reflective imprints on front and back. By PUMA for Mercedes-Benz. Sizes XS-XL. B6 695 8793-8797 \$75.95

37

# Kramski HPP 325 MB.

“The best or nothing.” Gottlieb Daimler’s quote offers possibly the most fitting explanation for the powerful radiance of KRAMSKI PUTTER. With this approach, the brand has been able to establish itself in the golf scene and in tournament events as a standard for ultimate precision and perfection in just a few years.



## The key features:

Striking surface	Plastic/metal mixture
Shaft	True Temper Double Bend
Putter head	Aluminium/carbide inserts
Colours	black, silver
Loft	3.25°
Lie	64-72°
Length	30-36 inch
High Precision Grip	S/M/L/XL/XXL

The individual and precise adjustment of the putter to the player is a significant part of the “Mastering the Green” philosophy of the brand. It takes place in a virtual fitting in the official KRAMSKI PUTTER Online Store.

**Ordering and online fitting\* directly at:**  
[kramski-putter.com/mercedes-benz](http://kramski-putter.com/mercedes-benz)

The HPP 325 MB is based on the same high-precision putter model (HPP), with which two legendary 59 rounds have already been played on par 72 courses at professional tournaments. Precision milled and colour anodised, this sporty, tuned mallet with a high-tech insert captivates in such a way that it has won great popularity amongst KRAMSKI tour players. The HPP 325 MB is available as a right or left-hand model with a specially developed precision handle. A design putter cover made from the finest leather is included.



\*Fitting also possible in the KRAMSKI PUTTING ACADEMY: [info@kramski-putter.com](mailto:info@kramski-putter.com)

### 1 MEN'S GOLF POLO SHIRT

Black. 83% polyester/13% cotton/4% elastane. 3-button fastening. Breast pocket. dryCELL technology. Performance fit. By PUMA for Mercedes-Benz. Sizes: S-XXL. B6 645 0332-0336 \$122.95

### 2 MEN'S GOLF POLO SHIRT

83% polyester/13% cotton/4% elastane. Three-button fastening. Breast pocket. dryCELL technology. Performance fit. By PUMA for Mercedes-Benz. Sizes S-XXL.

Black B6 645 0337-0341

Grey (not shown) B6 645 0342-0346 \$114.95



1-2

### 8 GOLF SWEATER

64% nylon/36% polyester. Stand-up collar. dryCELL technology, evoKNIT technology. Venting elements in heat zones. Performance fit. By PUMA for Mercedes-Benz.

Women. Grey. Sizes XS-XL.

B6 645 0369-0373 \$122.95

Men. Black. Sizes S-XXL.

B6 645 0347-0351 \$129.95

### 9 MEN'S GOLF POLO SHIRT

91% polyester/9% elastane. Three-button fastening. dryCELL technology. Performance fit. By PUMA for Mercedes-Benz. Sizes S-XXL.

Orange/black/white B6 645 0327-0331

Green/black/white (not shown) B6 645 0322-0326 \$114.95

All products on this page



3-4



6-7



8



9



5

### 3 LADIES' GOLF TOP

Fuchsia. 92% polyester/8% elastane. Stand-up collar with zip. dryCELL technology. Performance fit. By PUMA for Mercedes-Benz. Sizes XS-XL. B6 645 0364-0368 \$91.95

### 4 WOMEN'S GOLF POLO SHIRT

Fuchsia. 100% polyester. 5-button fastening. dryCELL technology. Performance fit. By PUMA for Mercedes-Benz. Sizes XS-XL. B6 645 0359-0363 \$82.95

### 5 CHILD'S GOLF POLO SHIRT

Green/black/white. 92% polyester/8% elastane. 3-button fastening. dryCELL technology. Performance fit. By PUMA for Mercedes-Benz. Sizes 116-164. B6 645 0379-0383 \$82.95

### 6 MEN'S GOLF WINDSHIRT

Black. 100% polyester. Water-repellant. windCELL technology. Zipper with chin guard. 2 zipped pockets. Performance fit. By PUMA for Mercedes-Benz. Sizes: S-XXL. B6 645 0352-0355 \$137.95

### 7 LADIES' GOLF WINDSHIRT

Black. 100% polyester. Water-repellant. windCELL technology. Two zipped side pockets. Fixable hood. Ventilation slit at the back. Performance fit. By PUMA for Mercedes-Benz. Sizes XS-XL. B6 645 0374-0378 \$122.95



10



11-12

### 10 CHILD'S GOLF CAP

Green. 100% polyester. Snapback fastener. Moisture-absorbing performance sweatband. Embroidered "P" logo with 3D-effect. By PUMA for Mercedes-Benz. Adjustable fit. B6 645 0384 \$30.95

### 11 GOLF CAP

Black. 100% polyester. Snapback fastener. Moisture-absorbing performance sweatband on the inside. "P" embroidered logo in 3D effect. By PUMA for Mercedes-Benz. Adjustable fit. B6 645 0357 \$45.95

### 12 GOLF CAP

Grey. 95% polyester/5% spandex. Moisture-absorbing performance sweatband on the inside. By PUMA for Mercedes-Benz. Adjustable fit. B6 645 0358 \$45.95

All products on this page





1-2



**1 GOLF CART BAG**

100% polyester. Compartments for 15 clubs with external putter pocket. Various pockets and pouches. Towel clip. Adjustable shoulder strap. Removable rain hood. Pass-through for cart strap for secure hold and easy access to pockets. By COBRA for Mercedes-Benz. Weight approx. 2.1 kg. Dimensions approx. 40x30x92 cm.

**White/fuchsia/black** B6 645 0386

**Black** (not shown) B6 645 0385

\$459.95

**2 GOLF SPORTS BAG**

100% polyester. Split main compartment with 2-way zip. Front pocket. Side pocket with external mesh pouch. Shoe pocket with breather holes. Padded, removable shoulder strap, adjustable in length. By COBRA for Mercedes-Benz.

Dimensions approx. 50x30x27 cm.

**White/fuchsia/black** B6 645 0389

**Black** (not shown) B6 645 0388

\$131.95

**5 GOLF BALLS, SET OF 3<sup>1</sup>**

White. Urethane. High Repulsion Core construction. For more length and control. By Bridgestone for Mercedes-Benz. B6 645 0394 \$37.95



5



3



**3 GOLF SHOE BAG**

Black. 100% polyester. Large main compartment with subcompartments. 2-way zipper. Wrist loop. Ventilation holes. By COBRA for Mercedes-Benz. Dimensions approx. 25x11x37 cm. B6 645 0390 \$60.95

**4 GOLF STAND BAG**

Black. 100% polyester. 14 club divisions. Various pockets and pouches. Towel clip. Shoulder carrier with quick-release fastener. EasyFlex base for maximum ground contact. Detachable rain hood. By COBRA for Mercedes-Benz. Weight approx. 2.1 kg. Dimensions approx. 34x37x87 cm. B6 645 0387 \$410.95



4



6



**6 GOLF CLUB HEADCOVER**

Black. 100% polyester. Drawstring on back. Water-repellent and dirt-repellent. By COBRA for Mercedes-Benz. Dimensions approx. 15x15x34 cm. B6 645 0391 \$36.95

**7 GOLF UMBRELLA**

Black. Water and dirt-repellent canopy with UV protection. Shaft and ribs in fibreglass. Totally metal-free. Windproof. Diameter when open approx. 130 cm. B6 695 2633 \$123.95



7

43

42

<sup>1</sup> Available from May 2019.





**1 CHILDREN'S BALANCE BIKE**  
 Aluminium frame. 12-inch "Schwalbe Big Apple" tires. Safety grips. Saddle height adjustable (approx. 41–47 cm). For heights of approx. 85 cm and over. Age 3+. Weight approx. 3.7 kg.  
**Purple** B6 645 0081  
**Green** (not shown) B6 645 0080  
**White/AMG** (not shown) B6 645 0127  
 \$325.95



**5 YOUTH BIKE**  
 Aluminium frame. 20-inch "Schwalbe Big Apple" tires. Shimano 7-speed derailleur. V-brakes. Robust metal mudguards. Aluminium stand. Saddle adjustable in height (approx. 60–73 cm). Age 6+, or height upwards of approx. 120 cm. Weight approx. 12.5 kg. Frame height 28 cm.  
**Green** B6 645 0082  
**Purple** (not shown) B6 645 0084  
**White/AMG** (not shown) B6 645 0083  
 \$728.95

**2 CHILDREN'S BIKE**  
 Aluminium frame. 16-inch "Schwalbe Big Apple" tires. Backpedal brake at rear. V-brake at front. Single-speed. Robust metal mudguards. Soft handlebar grips and stem with impact protection. Kick stand. Adjustable seat height (approx. 50–59 cm). Suitable for heights of approx. 105 cm and above, age 4+. Weight approx. 9.5 kg.  
**South Seas blue** B6 645 0065  
**Pink** (not shown) B6 645 0067  
 \$475.95



**6 JUNIOR BIKE**  
 Aluminium frame. Shimano 21-speed derailleur. V-brakes. 24-inch "Schwalbe Big Apple" tires. Robust metal mudguards. Saddle adjustable in height (approx. 67–80 cm). Age 8+, or height upwards of approx. 131 cm. Frame height approx. 31 cm. Weight approx. 12 kg.  
**Black** B6 645 0155  
**White/AMG** (not shown) B6 645 0156  
**White/purple** (not shown) B6 645 0157  
 \$915.95



**3 CHILDREN'S BIKE**  
 Aluminium frame. 16-inch "Schwalbe Big Apple" tires. Backpedal brake at rear. V-brake at front. Single speed. Robust metal mudguards. Soft handlebar grips and stem with impact protection. Kick stand. Adjustable seat height (approx. 50–59 cm). Suitable for heights upwards of approx. 105 cm, age 4+. Weight approx. 9.5 kg.  
 B6 645 0148  
 \$475.95



**7 CRATER LAKE FITNESS BIKE**  
 Black. Exclusive design with aluminium frame, 27 gears, suspension fork, disc brakes and 28-inch wheels. Weighs approx. 13.5 kg. Load capacity of up to approx. 100 kg. By FOCUS for Mercedes-Benz. Made in Germany.  
 B6 645 0108, -0109, -0192, -0111  
 \$1,864.95

**4 SCOOTER**  
 Black. Aluminium. Fully collapsible. Rubber-coated, folding handles. Suspension fork. Handlebars adjustable in height. 200 mm rollers with ABEC 9 ball bearings. Foot brake. Kick stand. Age 12+. Maximum load approx. 100 kg. Weight approx. 6.5 kg. Dimensions when folded approx. 86 x 35 x 12 cm. Foot length on running board approx. 34 cm.  
 B6 695 5043  
 \$358.95



<b>FRAME</b>	aluminium
<b>FORK</b>	SR Suntour NEX HLO, 63 mm, lockout
<b>WHEELSET</b>	Concept
<b>TIRES</b>	Schwalbe Smart Sam (Crater Lake) Schwalbe Citizen Light 42-622 (Aventura)
<b>CHAIN RINGS</b>	Shimano Alivio
<b>CRANK SET</b>	Shimano Acera
<b>GEAR RATIO</b>	front: 48/36/26, rear: 11–34
<b>SHIFTER</b>	Shimano Acera
<b>REAR DERAILLEUR</b>	Shimano Deore, 9-speed
<b>FRONT DERAILLEUR</b>	Shimano Acera
<b>BRAKES</b>	Tektro HD-M285, 160 mm/160 mm hydraulic disc brake
<b>STEM/HANDLEBARS</b>	Concept
<b>EXTRAS FOR AVENTURA</b>	
<b>MUDGUARD/REAR CARRIER</b>	Büchel Sport/Carrier Sport
<b>SADDLE/SEAT POST</b>	Concept Cross/Concept, 31.6 mm
<b>FRONT LIGHT</b>	Basta Echo 15, with switch
<b>REAR LIGHT</b>	Herrmans H-TRACE

**8 SPORT SUNGLASSES**  
 Black/blue plastic frame. Transparent/grey lenses. Lens shade adapts to light conditions. 100% UV-A/UV-B protection (UV-400). Filter category 1–3. Anti-reflective coating. B6 695 3504  
 \$194.95



For choice of size and geometry, see p. 108.



**YOUTH T-SHIRT**

Off-white/red. 100% cotton. Short sleeves. Boat neck. Patterned neck tape. Modern fit. Reversible sequins with red heart and Mercedes star. Sizes 116/122-152/158. B6 695 4296-4299 \$52.95

**REVERSIBLE BEAR/G-CLASS**

See p. 51

**YOUTH T-SHIRT**

Light blue. 100% cotton. Short sleeves. Crew neck with blue ribbed cuffs. Patterned neck tape. Robots print on front. Modern fit. Silver-grey Mercedes star on left sleeve. Sizes 116/122-152/158. B6 695 4460-4463 \$52.95

**YOUTH NECK POUCH**

See p. 48

**YOUTH BOARDSHORTS**

Blue. 100% polyester. Zipped side pockets. Elastic waistband with part drawstring and cord. Embroidered badge with Mercedes-Benz star in silver grey on the bottom of the left leg. Sizes 116/122-152/158. B6 695 4515-4518 \$35.95

**YOUTH RUCKSACK, LARGE**

See p. 48



# Let's little ones enjoy a big success.

Should your offspring wear anything other than the best? We don't think so and have designed what looks good on kids and what they like: items of clothing that are as beautiful as they are robust, colourful bags and rucksacks as well as exclusive toys. This means even little ones can enjoy a big success.

**THE MERCEDES-BENZ COLLECTION**

### 1 NECK POUCH

Polyester. Illuminated Mercedes-Benz robots. Key ring. Transparent pane at the rear. Cord with child-protection mechanism. Mercedes star embroidered on front. Lining with Mercedes-Benz proprietary pattern. By Lässig for Mercedes-Benz. Dimensions approx. 12x0.5x13 cm.

**Black/blue** B6 695 4038  
**Black/pink** B6 695 4039  
\$30.95



### 2 LARGE RUCKSACK

Polyester. Water-repellent. Insulated front pouch. Two small zipped compartments. Transparent field for identity card. Padded shoulder straps. Illuminated Mercedes-Benz robots. Mercedes star embroidered on front. Lining with Mercedes-Benz proprietary pattern. By Lässig for Mercedes-Benz. Dimensions approx. 32x18x42 cm.

**Black/pink** B6 695 5768  
**Black/blue** B6 695 5767  
\$84.95

### 3 SMALL RUCKSACK

Polyester. Water-repellent. Large main compartment. Separate compartment for cooling block. Small extra pocket on the front. Net pocket on the outside for drinking bottle. Transparent pane for identity card. Padded, adjustable shoulder strap. Chest strap. Illuminated Mercedes-Benz robots. Mercedes star embroidered on front. Lining with Mercedes-Benz proprietary pattern. By Lässig for Mercedes-Benz. Dimensions approx. 24.5x15.5x27 cm.

**Black/pink** B6 695 5770  
**Black/blue** B6 695 5769  
\$63.95



### 4 TROLLEY

Polyester. Water-repellent. Functional interior trim with packing straps. Various outside pockets. With practical shoe bag. Adjustable grip. Transparent field for identity card. Illuminated Mercedes-Benz robots. Mercedes star embroidered on front. Lining and shoe bag with Mercedes-Benz proprietary pattern. By Lässig for Mercedes-Benz. Dimensions approx. 29.5x19.5x46 cm.

**Black/pink** B6 695 5201  
**Black/blue** B6 695 5202  
\$126.95

All products on this page



**1 CARL KEY RING**

Beige. Polyester plush. Flat split ring. Stitched-on woven label featuring Mercedes star. Dimensions approx. 12x4x6 cm. B6 695 3238 \$17.95

**2 CARL HOT-WATER BOTTLE**

Beige/cream. Rubber/polyester plush. Case washable at 30°C. 3D star stud in ear. Stitched-in fly label featuring Mercedes star. Dimensions approx. 22x12x50 cm. B6 695 3692 \$54.95

**3 CARL SEATBELT PAD**

Cream/beige. Polyester plush. Longitudinal continuous Velcro fastener on the rear. Washable at 30 °C. Sewn-on bear application. Stitched-in woven label featuring Mercedes star. Dimensions approx. 9x4x20 cm. B6 695 3693 \$37.95



1-2

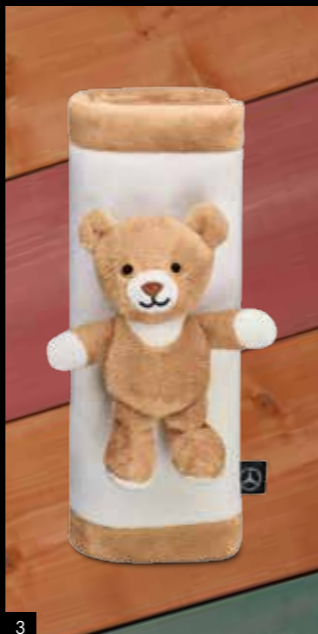

3



5

4

6

**4 CARL HOODED TOWEL**

Cream/beige. 95% cotton/5% polyester. OEKO-TEX® Standard 100. Washable at 60 °C. Suitable for tumble drying. Stitched-in woven label featuring Mercedes star. Dimensions approx. 100x100 cm. B6 695 3691 \$76.95

**5 CARL CHILDREN'S BLANKET WITH CUSHION FUNCTION**

Beige. Polyester plush. Can be used as a cushion when folded up. Blanket can be stored in the cushion part. Dimensions of blanket approx. 100x120 cm. Dimensions of cushion approx. 38x12x30 cm. B6 695 3260 \$88.95

**6 CARL COMFORT BLANKET**

Beige. Polyester plush. Size approx. 30x7x33 cm. B6 695 3259 \$24.95



7



9

**7 PACIFIER**

Plastic/silicone. Orthodontic silicone dummy. With grab ring. Protective cap and storage box. Made in Germany. Size 1 (from 0 months). Purple/yellow B6 695 3250 Green/yellow (not shown) B6 695 3249 \$13.95

**8 CHILDREN'S SUNGLASSES**

Plastic frames. Soft, ultra-flexible side arms. Grey lenses by Carl Zeiss Vision. 100% UV-A-/UV-B protection (UV-400). Filter category 3. Purple/grey B6 695 3502 Green/yellow (not shown) B6 695 3503 \$70.95

**9 PLUSH SLIPPERS**

Red. Polyester plush. G-Class design. Anti-slip soles. Embroidered radiator grille and headlamp details. Woven Mercedes star label. Shoe size 28-33 B6 695 3257 Shoe size 34-39 B6 695 3258 \$57.95



8



10

**10 REVERSIBLE BEAR/G-CLASS**

Beige/red. Polyester plush. Zip on back of bear/base of car for changing between bear and G-Class. Size approx. 35 cm. B6 695 2860 \$94.95

**11 CHILDREN'S SUITCASE**

Red/black. Polypropylene. Practical organisation features inside with elasticated packing straps in lower compartment and divider in upper compartment. Wheels. Extendable pulling strap and pulling bar. Lid locked by means of two side latches. Dimensions approx. 48x24x20 cm. B6 695 4102 \$193.95



11



# Your design story begins now.

The exclusive Mercedes-Benz Classic Collection finds legendary style icons from the unique Mercedes-Benz history. It takes up the timeless, stylistic line and impresses with the unique Mercedes-Benz craftsmanship. Classic cuts and high-quality materials create its own series in which every collector's item fits perfectly to the other.

**MEN'S LEATHER JACKET**  
See p. 54

**MEN'S PULLOVER**  
See p. 61

**MEN'S CLASSIC AUTOMATIC WRISTWATCH**  
Bronze case with stainless steel back. Brown dial. Bronze-coloured hand. Anti-reflective sapphire glass on both sides. Brown leather strap. Water-resistant to 5 ATM. Diameter 42 mm. Sellita SW 200 automatic movement. Swiss made. B6 604 1677  
\$1,330.95



SCAN THE QR CODE AND EXPERIENCE THE COLLECTION.

[http://mb4.me/MBA\\_Classic\\_Collection](http://mb4.me/MBA_Classic_Collection)

THE MERCEDES-BENZ CLASSIC COLLECTION

# Heinz Bauer Manufakt.



1 In 1960, Heinz and Margot Bauer established the traditional Swabian company called Heinz Bauer Manufakt. At an early stage, the couple started producing their own jacket collection with great success. Today, Jochen Bauer is the second generation at the helm of the company. With time, the company developed a great collection and international reputation with innovative details, rooted in a passion for driving convertibles.



54



## 1 MEN'S LEATHER JACKET

Brown. Outer material 100% cowhide, lining 51% cotton / 49% viscose. Removable collar with zip. Robust shoulder and sleeve padding. Smocked sections on cuffs and seam. Perforated sections on front section, back section and sleeves. Modern fit. By Heinz Bauer Manufakt for Mercedes-Benz. Sizes 48-56. B6 604 1631-1635 \$3,935.95



## USE THE WALLET FUNCTION OF YOUR SMARTPHONE

Simply scan the QR code and you will have the opportunity to clearly store the high-quality personal accessories from the Mercedes-Benz Collection on your mobile phone. Once stored, you are always up to date, wherever you are.



2



3

## 2 CAP

Dark brown. Outer material 100% cowhide, lining 51% cotton / 49% viscose. Folding draft stop. Refined quilting on front section. Perforated leather under sign. Eyelets for optimum air circulation. By Heinz Bauer Manufakt for Mercedes-Benz. Sizes 55-59. B6 604 8052-8056 \$453.95

## 3 MEN'S LEATHER GLOVES

Brown. 100% cowhide. Perforated and quilted inserts. Leather band can be adjusted in width featuring press studs. By Heinz Bauer Manufakt for Mercedes-Benz. Sizes 8, 8.5, 9, 9.5. B6 604 1666-1669 \$301.95

55

**1 300 SL SHIFT LEVER KNOB GUEST UMBRELLA**

Brown. 100% polyester canopy with water- and dirt-repellent coating. Steel shaft, fibreglass ribs. Windproof. Diameter when open approx. 130 cm. B6 604 3226 \$53.95



**2 RUCKSACK<sup>1</sup>**

Dark brown. Cowhide. Various compartments. Breathable rear face with strap including safety pocket with zipper for securing onto the trolley handle. Carrying handle. Padded, breathable and adjustable shoulder carrier. Detachable address tag. By Bric's for Mercedes-Benz. Dimensions approx. 30 x 18 x 43 cm. B6 604 2013 \$714.95

**3 BUSINESS BAG<sup>1</sup>**

Dark brown. Cowhide. Various inside and side compartments. Identity tag. Removable shoulder strap. Mercedes-Benz Classic embossing on inside and outside. By Bric's for Mercedes-Benz. Dimensions approx. 38 x 7 x 28 cm. B6 604 2012 \$609.95

**4 WEEKEND BAG<sup>1</sup>**

Dark brown. Cowhide. Various pockets. Straps on back section for attachment to the trolley suitcase. Shoulder straps. Reinforced base. Feet in base. Mercedes-Benz Classic embossing on inside and outside. By Bric's for Mercedes-Benz. Dimensions approx. 55 x 20 x 32 cm. B6 604 2011 \$1,099.95



2-4



5



6

**5 WALLET<sup>1</sup>**

Dark brown. Cowhide. Twofold bank note compartment. Loose change compartment. Various card slots. Folding, transparent ID pocket. RFID protection. By Bric's for Mercedes-Benz. Dimensions approx. 12.5 x 9.5 cm. B6 604 2014 \$161.95

**6 TROLLEY WITH 4 ROLLERS<sup>1</sup>**

Beige/dark brown. Polycarbonate Makrolon® / cowhide. Two inner compartments. Pull-out handle with three fixed positions. Double rollers with rubber coating. Integrated TSA lock. Identity tag. Mercedes-Benz Classic embossing on inside and outside. By Bric's for Mercedes-Benz. Dimensions approx. 38 x 20 x 50 cm. B6 604 2015 \$814.95

All products on this page



<sup>1</sup> Available from May 2019.



1-2

**1 COVER**

Brown. Aluminium/polycarbonate/polycarbonate. Protects the casing against scratches. Mercedes "Vintage star" logo.

**iPhone® X/iPhone® XS**  
B6 604 2018

**Samsung Galaxy S9 (not shown)**  
B6 604 2019  
\$52.95

**2 COVER**

Multicoloured. Acrylic/polycarbonate. Protects the casing against scratches. Retro print with racing car motif. Vintage "Mercedes" lettering on the inside.

**iPhone® X/iPhone® XS**  
Suitable for wireless charging.  
B6 604 2020

**Samsung Galaxy S9 (not shown)**  
B6 604 2021  
\$52.95

**3 MERCEDES SCRIPT KEY RING**

Stainless steel. Flat keyring with 3 smaller split rings for quick removal/replacement of individual keys. Length approx. 11 cm.

**Gold-coloured/blue** B6 604 1518  
**Silver-coloured/blue** (not shown)  
B6 604 1675  
\$95.95

**4 STUTTGART KEY RING**

Silver-coloured. Stainless steel. Flat split ring with three additional mini split rings for quick removal/replacement of individual keys. Made in Germany. Length approx. 9 cm.  
B6 604 1524  
\$59.95



3



4



5



6



**5 BALLPOINT PEN**

Metal barrel. Twist-action. Mercedes star on top of cap.

**Red/silver-coloured**  
B6 604 3351

**Black/silver-coloured** (not shown)  
B6 604 3350

**Silver-coloured** (not shown)  
B6 604 3352  
\$9.95

**6 CRYSTAL BALLPOINT PEN**

Rose gold colours. Brass/glass. Swarovski® Crystal Fine Rocks on barrel. Twist cap. Writes in blue. Vintage logo lasered on the top side.

Made for Mercedes-Benz by Swarovski®. B6 604 1612  
\$130.95

**7 300 SL COMPUTER MOUSE**

Red. Wireless. In form of 300 SL. LED headlamps and tail lights with On/Off switch. 2.4 GHz wireless technology. USB nano receiver. High-resolution optical sensor with switchable sensitivity (between 800 dpi and 1600 dpi). Compatible with all standard operating systems.  
B6 604 1625  
\$98.95



7



8

**8 MEN'S JACKET**

Black. Outer material 60% cotton/40% polyester, quilted taffeta lining 100% polyester. Wind- and water-repellent. 2-way front zip closing. Stand-up collar with catch and 2 press stud fasteners. Various pockets. Sleeve end with zipper. Shoulder and elbow area quilted and slightly padded. Modern fit. "Vintage star" metal badge in the chest area, embossed "Mercedes" lettering on the back, embossed vintage laurel leaves on sleeves. Sizes: S-XXL. B6 604 1646-1650  
\$361.95

9

**9 MEN'S T-SHIRT**

Black. 100% cotton. Crew neck. Racing car retro print on the front. Vintage laurel leaf print on the sleeves. Woven neckband with checked design. Slim fit. Vintage star on front. Vintage "Mercedes" lettering on the back section. Sizes: S-XXL.  
B6 604 1670-1674  
\$66.95

**10 SINDELFINGEN KEY RING**

Gold-plated brass. Flat split ring with three mini split rings for quick removal/replacement of individual keys. Made in Germany. Length approx. 9 cm.  
B6 604 1523  
\$53.95

**11 MEN'S CHRONOGRAPH, CLASSIC RALLEY**

Square stainless steel case. Black and beige dial with bordeaux red outline. Steel-coloured hands with Super-LumiNova® detail, bordeaux red second hand.

Anti-reflective sapphire glass on both sides. Black calfskin strap with perforation and red lining. Water-resistant to 5 ATM. Dimensions 40x40 mm. Ronda Z60 quartz movement. Swiss made. B6 604 1679  
\$500.95

**12 COVER**

Black/white/red. Acrylic/polycarbonate. Protects the casing against scratches. Mercedes "Vintage star" logo.

**iPhone® X/iPhone® XS** Suitable for wireless charging.  
B6 604 2016

**Samsung Galaxy S9 (not shown)**  
B6 604 2017  
\$52.95

10

11

12

58

59





1-4

**1 MEN'S JACKET**

Navy. Outer material 46% cotton/36% polyester/18% polyamide, split inner lining: Woven chequered at top: 100% cotton, quilted lining below: 100% polyester with lightweight padding. Wind- and water-repellent. High-closing collar. Pleats. 2-way zipper. Stand-up collar with catch and press stud fastener. 4 attached pockets. Side latch with press stud fastener for adjustment of the waist size. Modern fit. A matching gilet (B6 604 1656-B6 604 1660) attachable into the jacket with press studs can be purchased separately. Sizes: S-XXL. B6 604 1636-1640 \$487.95

**2 MEN'S VEST**

Navy. Outer material and lining: 100% polyamide. Wadding: 100% polyester. Extra high collar. Elastic side rib sections. Zipped pocket inside. Buttoned in men's jacket (B6 604 1636-1640). Modern fit. Sizes: S-XXL. B6 604 1656-1660 \$216.95

**3 LADIES' JACKET**

Black. Outer material 46% cotton/36% polyester/18% polyamide, split inner lining: Woven chequered at top: 100% cotton, quilted lining below: 100% polyester with lightweight padding. Wind- and water-repellent. High-closing collar. Pleats. 2-way zipper. Stand-up collar with catch and press stud fastener. 4 attached pockets. Belt for adjustment of waist size. Modern fit. A matching gilet (B6 604 1651-B6 604 1655) attachable into the jacket with press studs can be purchased separately. Sizes XS-XL. B6 604 1641-1645 \$469.95

**4 WOMEN'S VEST**

Black. Outer material and lining: 100% polyamide. Wadding: 100% polyester. Extra high collar. Elastic side rib sections. Zipped pocket inside. Modern fit. Buttoned in women's jacket (B6 604 1641-B6 604 1645). Sizes XS-XL. B6 604 1651-1655 \$180.95



5



7



6



8

**5 FLAT CAP**

Brown/beige. Polyester. Herringbone design. One size. B6 604 1503 \$70.95

**6 CAP**

Black. 100% cotton. Vintage star embroidered on front, trimmed with Swarovski® crystals. Embroidered vintage "Mercedes" lettering on left side in gold. Metal clasp for adjusting fit. B6 604 1517 \$35.95

**7 CAP**

Navy with off-white contrasts. 100% cotton. Strap with metal clasp, embossed with star logo, for adjusting fit. B6 604 1540 \$35.95

**8 300 SL CUFF LINKS**

Bronze. Front with wave structure from the interior of the 300 SL, vintage Mercedes-Benz logo on the back. Diameter approx. 1.5 cm. B6 604 3326 \$108.95



9-10

**9 MEN'S POLO SHIRT**

Black. 95% cotton/5% elastane. Button band. Collar and cuffs in single rib. Slim Fit. 1926 classic logo badge on front section. Sizes S-XXL. B6 604 1597-1601 \$88.95

**10 MEN'S POLO SHIRT**

Navy. Neck tape and inside of collar in off-white. 100% cotton piqué. Sizes S-XXL. B6 604 1535-1539 \$69.95

**11 MEN'S SHIRT**

100% cotton. Single-rib cuffs. Classic 1926 logo overprinted on front and in nape. Sizes S-XXL.

Offwhite B6 604 1546-1550

Navy (not shown) B6 604 1551-1555 \$52.95

**12 MEN'S POLO SHIRT**

100% cotton. Contrasting neck band and side vent trim. Single-rib collar and cuffs. Button front. Modern fit. 1926 Classic logo badge and vintage Mercedes lettering embroidered on the back section in high-gloss thread. Sizes S-XXL.

Black B6 604 1592-1596

Bordeaux (not shown) B6 604 1587-1591 \$176.95

**13 LADIES' POLO SHIRT**

Navy. Contrasting neck tape and side vent trim. 100% cotton. Short sleeves. Single-rib collar and cuffs. Button band. Modern fit. 1926 classic logo badge and vintage Mercedes lettering embroidered on the back section in high-gloss thread. Sizes XS-XL. B6 604 1582-1586

\$142.95

**14 LADIES' POLO SHIRT**

95% cotton/5% elastane. Vintage Mercedes star, adorned with Swarovski® crystals on front. Gold-coloured "Mercedes" lettering on right sleeve. Sizes XS-XL.

Black/gold-coloured B6 604 1510-1514 \$69.95

Red/gold-coloured (not shown) B6 604 1602-1606 \$88.95

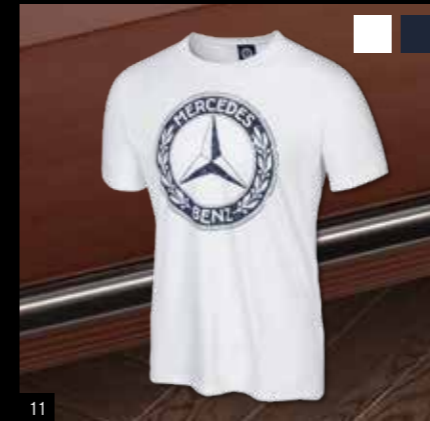

11



12



13-14



**15 MEN'S PULLOVER**

Navy/cognac. Outer material 45% polyamide/35% merino wool/20% cotton. Lining 100% polyester. Windproof. Breathable. High-closing rib collar. Front, rear and sleeves knitted in a mix of patterns. Sleeves and hem rounded off with single-rib. Applications in suede look. "Historic star" badge on the sleeve. Knitted, tonal "Mercedes-Benz" lettering on back. Sizes: S-XXL. B6 604 1661-1665 \$299.95



15



1

### 3 WOMEN'S CLASSIC LADY ROMAN WATCH

Stainless steel case with gold-coloured PVD coating. Silver-coloured dial with gold-coloured Roman numerals and hour markers. Gold-coloured hands. Stainless steel Milanese mesh strap with gold-coloured PVD coating. Water-resistant to 5 ATM. Diameter 34 mm. Ronda 773 quartz movement. Swiss movt. B6 604 1570 \$345.95

### 4 WOMEN'S WATCH, CLASSIC LADY SILVER

Stainless steel case. Silver-coloured dial with steel-coloured Roman numerals and hour markers. Silver-coloured hands. Stainless steel Milanese mesh strap. Water-resistant to 5 ATM. Diameter 34 mm. Ronda 773 quartz movement. Swiss movt. B6 604 1621 \$318.95

### 5 MEN'S CLASSIC RETRO GOLD CHRONO-GRAPH WATCH

Stainless steel case with rose gold-coloured PVD coating. Silver-coloured dial with hours and minutes, Super-LumiNova® luminous dots and three-dimensional cap structure in centre. Leather strap with crocodile effect. Rose gold-coloured luminous hands. Stopwatch function. Water-resistant to 5 ATM. Diameter approx. 42 mm. Ronda 5030 Swiss quartz movement. Swiss movt. B6 604 1617 \$486.95

### 6 300 SL DESK CLOCK

Silver-coloured. Aluminium/stainless steel. In the shape of the 300 SL. Wave pattern on dial. Dimensions approx. 20x3.5x6 cm. B6 604 1613 \$88.95



2

### 1 COMPACT UMBRELLA<sup>1</sup>

Dark brown. Canopy 100% polyester. Aluminium frame. Fibreglass/aluminium rails. Hook handle with genuine leather trim. Automatic opening and closing. Windproof design. Fastening tab with Velcro fastener. Matching case with zipper. Diameter when open approx. 103 cm. Length approx. 35 cm. B6 604 1681 \$181.95

### 2 MEN'S CHRONOGRAPH WATCH, CLASSIC 300 SL

Stainless steel case with red colour outlay on front side of pushpiece. Beige-metallic dial with red and brown accents, simulated wave structure in the counter eyes and 300 SL emblem. Brown calfskin strap with red seam and perforated design. Steel-coloured hands. Stopwatch function. Water-resistant to 10 ATM. Diameter approx. 44 mm. Ronda 5021.D Swiss quartz movement. Swiss made. B6 604 1615 \$622.95



3



4



5



6



7

### 7 NODDING DOG

Brown. Plastic with synthetic fur. Gold-coloured collar with brass Mercedes star logo tag. Made in Germany. Size: approx. 29 x 18 cm. B6 604 1451 \$47.95



8-9

### 9 WINE STOPPERS, SET OF 4

Various colours. Wood/stainless steel. Gear shift knob design. 3 wine stoppers with a wooden head, 1 champagne stopper with stainless steel head. In high-quality gift packaging. Dimensions of packaging approx. 21.5 x 15.5 x 5.5 cm. B6 604 5160 \$112.95

### 10 PICNIC HAMPER<sup>1</sup>

Dark brown. Polyrattan. Fasteners and carrying handles made from leather. Reinforced carry handles made from canvas. Content: 2 x cutlery set, 2 x porcelain dishes, 2 x coffee cups, 2 x juice glasses, 1 x pepper pot, 1 x salt pot, 2 x serviettes 40 x 40 cm, 1 x tablecloth 140 x 140 cm. Dimensions approx. 50 x 34 x 31 cm. B6 604 1562 \$514.95

### 11 SENATOR THERMAL FLASK, 1.0 L

Silver-coloured/dark brown. Stainless steel. Real leather gaiter. Double-walled. Keeps drinks cool for up to 24 hours and hot for up to 12 hours. 100% sealed. With integrated drinking cup. By esma for Mercedes-Benz. Diameter approx. 9 cm. Height approx. 30 cm. Capacity approx. 1.0 l. B6 604 5701 \$90.95

### 12 CLASSIC PICNIC BLANKET

Brown/ivory. Upper side made from soft polyester fleece, bottom made from water-repellent polyamide fabric. Pull strap with size-adjustable strap and carrying handle. By Fraas for Mercedes-Benz. Size: approx. 140 x 200 cm. B6 604 1563 \$112.95

### 13 CUDDLY BEAR

Beige. Polyester plush. By NICI for Mercedes-Benz. Size approx. 35 cm. B6 604 1559 \$94.95



10



11



12



13

<sup>1</sup> Available from May 2019.

# Form follows fun.

Whether you drive a Sprinter for work, privately use a Marco Polo or an X-Class accompanies you everywhere – the new Mercedes-Benz Van Collection offers fascinating products that inspire not only drivers, but also fans. Look forward to products in which functionality is at the fore, but the design also speaks for itself.



#### MEN'S SOFTSHELL JACKET

Black / silver-grey. 100% polyester. Zipped and size-adjustable hood. Width-adjustable cuffs and with additional elastic cuffs, which can be pulled out if necessary. Ventilation studs in underarm area. Inner lining with two attached pockets. Sizes: S-XXL. B6 787 1263-1267 \$144.95

#### MEN'S T-SHIRT

Black / dark grey / white. 100% cotton. Crew neck. Modern fit. Tire print and "Sprinter" lettering at the front. Tonal star logo embroidered on left sleeve. Sizes: S-XXL. B6 787 1257-1261 \$37.95

#### FOLDING CHAIR

Black. Tubular steel frame with hard-wearing polyester cover. Armrests with drinks holder. Mercedes-Benz lettering embroidered on back. Transport bag. Load capacity of up to 160 kg. Packing size approx. 17 x 97 cm. Weight approx. 4.5 kg. B6 787 1621 \$114.95

#### CAP

Black. 100% cotton. Adjustable fit. B6 787 1649 \$33.95

THE MERCEDES-BENZ VAN COLLECTION



1



2



3

### 1 PORTFOLIO

Black. Polyester/polyurethane. All-round zip fastening. Dimensions approx. 25x34 cm. B6 787 2008 \$44.95

### 2 CASE FOR iPhone® X/iPhone® XS

Black. 50% polyethylene/50% polyurethane. Protects the casing against scratches. Tire profile imprint and white "Sprinter" lettering. Suitable for NFC stickers and wireless charging. B6 787 2460 \$33.95

### 3 LAMY LOGO BALLPOINT PEN

Mountain grey/silver-coloured. Plastic/stainless steel. Push-action. Blue ink. Takes LAMY M 16 large-capacity refills. Silver-coloured Mercedes-Benz logo print on barrel. In decorative test tube packaging. By LAMY for Mercedes-Benz. Made in Germany.

Sprinter logo overprint on shank B6 787 2039

Vito logo overprint on shank B6 787 2040

Citan logo overprint on shank B6 787 2041 \$29.95



4



5

### 4 REVERSIBLE FLEECE BLANKET

Black/anthracite. 100% polyester fleece. Mercedes star embossed on front. Size approx. 150x200 cm. B6 787 1618 \$67.95

### 5 LED FLASHLIGHT, SMALL

Black. Aluminium. 80 lumen. Run-time of approx. 10 hours. Beam range of up to 150 m. Length approx. 16 cm. B6 695 3318 \$42.95

### 6 ZIPPO® LIGHTER

Black. Brass. By Zippo® for Mercedes-Benz. Made in USA. Dimensions approx. 3.9x1.5x5.8 cm. B6 695 3357 \$98.95

### 7 VICTORINOX SWISS CHAMP PENKNIFE

Black. Stainless steel/plastic. Officer's knife with 33 tools. By Victorinox for Mercedes-Benz. Length approx. 9.1 cm. Weighs approx. 185 g. B6 695 3410 \$160.95



6



7

### 8 SLEEPING BAG

Black/beige. Outer and inner material 100% nylon, filling in polyester. Mummy-style sleeping bag. All-round zip fastening. Opens fully for use as a quilt. Temperature range +13°C to -3°C. Suitable for height of up to 185 cm. By Deuter for Mercedes-Benz. Size approx. 205x75x48 cm. Weighs approx. 600 g. Packaging dimensions approx. 10x16 cm. B6 787 1197 \$179.95



9

10

11

12

8



**9 WASH BAG**  
Black/beige. Polyester. With hanger accessory. Various pouches and mesh pockets. Removable mirror. Clip fastener. Dimensions approx. 50x30 cm. B6 787 1199 \$41.95

**10 VICTORINOX MULTIFUNCTION TOOL** Silver-coloured. Stainless steel. 28 tools. Star logo etched on handle. Black leather pouch with belt loop. By Victorinox for Mercedes-Benz. Swiss made. Size with pouch approx. 4x12x3.5 cm. B6 695 3417 \$334.95

**11 LED FLASHLIGHT, LARGE**  
Black. Aluminium. 260 lumen. Run-time of approx. 50 hours. Beam range of up to 160 m. Focus control. Length approx. 32 cm. B6 695 3317 \$105.95

**12 VICTORINOX CLIMBER SWISS ARMY KNIFE** Black. Stainless steel/plastic. Large and small blade, scissors, multipurpose hook, bottle opener, can opener, reamer, punch and sewing awl, corkscrew, ring and tweezers. By Victorinox for Mercedes-Benz. Length approx. 9.1 cm. B6 695 3409 \$69.95



1

#### 1 RWANDA FLEECE

Black / anthracite. Polyester. Mercedes star logo on front. By Fraas for Mercedes-Benz. Dimensions approx. 150 x 160 cm. B6 695 3627 \$83.95

#### 2 PICNIC BLANKET

Khaki / sand beige. Upper side made from soft polyester fleece, bottom made from water-repellent polyamide fabric. Pull strap with size-adjustable strap and carrying handle. Storage bag with logo print. By Fraas for Mercedes-Benz. B6 695 4747 \$89.95

#### 3 BEACH UMBRELLA

Black / beige. 100% polyester. Fibreglass rails and lockable fibreglass lower shaft. Waterproof. UV 50+ protection. Windproof design. Opened manually. Space-saving travel size. Diameter approx. 147 cm. Length when closed approx. 71 cm. B6 695 4748 \$112.95



2



3



4



6

#### 4 MEN'S T-SHIRT

Black. 100% cotton. Crew neck. Modern fit. Mercedes star logo on sleeve. Silhouette of the X-Class as reflective print on front section. Sizes: S-XXL. B6 787 1269-1273 \$39.95

#### 5 USB FLASH DRIVE

White / grey / black. PVC. In the form of the Mercedes-Benz X-Class in 2D. 32 GB. USB 3.0 interface. Compatible with all standard operating systems. Dimensions approx. 6 x 3.5 x 0.9 cm. B6 787 1275 \$66.95

#### 6 GRILL BRANDING IRON<sup>1</sup>

Silver-coloured. Stainless steel / beechwood / leather. Mercedes star logo as branding image. Mercedes-Benz lettering burned into the wooden handle. Grip length approx. 40 cm. Diameter of branding image approx. 10 cm. B6 695 4736 \$56.95

#### ICE-CUBE MOULD X-CLASS (NOT SHOWN)<sup>1</sup>

Black. Silicone. Raised tonal Mercedes star on top silicone section. Dimensions approx. 23 x 16 x 2 cm. B6 695 4746 \$22.95



5



7



8

#### 7 FLIP\*FLOPS, X-CLASS

Black. Plastic. EVA granule sole. X-Class laser print on outer sole, X-Class punched onto the sole underside. Toe strap with raised Mercedes star. Textile bag with logo print for storage. Sizes S (37/38), M (39/40), L (41/42), XL (44/45). B6 695 5183-5186 \$67.95

#### 8 WATER FLOAT, X-CLASS<sup>1</sup>

Transparent / silver-coloured. PVC. Two grab handles. Diameter approx. 120 cm. B6 695 4739 \$67.95

# Made for doers.

Freedom, boundlessness and adventure – the Mercedes-Benz Trucks Collection is perfect for the roads of this world. Many products take up the design of the Actros radiator grille. Durable materials and cool cuts bring the Mercedes-Benz Trucks lifestyle to life. Feel free!



SCAN THE QR CODE AND EXPERIENCE THE COLLECTION.

[http://mb4.me/MBA\\_Trucks\\_Collection](http://mb4.me/MBA_Trucks_Collection)

**CAP**  
Black. Cotton/polyester mesh. Actros radiator grille print and Mercedes star embroidered on front section, Actros embroidered on back section. Adjustable fit. B6 787 1301 \$33.95



## MEN'S SOFTSHELL JACKET

Black/red. Outer material 100% polyester, inner material 100% polyester fleece. Removable, width- and size-adjustable hood. Cuffs with adjustable Velcro fastening. Metal underarm ventilation eyelets. Various pockets. Width-adjustable waistband. High-closing front zip fastening with chin guard. Reflective print on hood, sleeves and back. Modern fit. Sizes: S-XXL. B6 787 1239-1244 \$149.95

## MEN'S TRUCKS WRISTWATCH

See p. 72

## TRAVEL BAG

Black. Polyester. Large inside compartment, shoe compartment on the side and inside pocket. 2-way zipper. Adjustable shoulder strap with anti-slip padding. Dimensions approx. 65x32.5x35 cm. B6 787 1669 \$83.95

## MEN'S BELT

Black. Cowhide. Shortenable. Length approx. 140 cm. Width approx. 4 cm. B6 787 1635 \$76.95



## MEN'S POLO SHIRT

Black/red. 100% cotton. Single-rib collar and cuffs. Button band. Red woven stripes on the collar and cuffs. Band on side vents, Actros radiator grille elements imprinted on button band and in the neck. Modern fit. Sizes S-XXXL. B6 787 1245-1250 \$49.95



THE MERCEDES-BENZ TRUCKS COLLECTION

### 1 MEN'S TRUCKS WRISTWATCH

Stainless steel case with crown protection. Black dial with partially red digits. Hands with Super-LumiNova® detail. Hardened mineral crystal. Black silicone strap. Water-resistant to 10 ATM. Diameter 42 mm. Quartz movement. B6 787 1195 \$161.95

### 2 COVER FOR SAMSUNG GALAXY

Black. Polycarbonate/polyurethane. Protects the casing against scratches. Actros logo. Samsung Galaxy S5 mini B6 787 2459 Samsung Galaxy S8 (not shown) B6 787 2092 \$37.95

### 3 PORTFOLIO

Black/red. Polyester/polyurethane. All-round zip fastening. Dimensions approx. 25x34 cm. B6 787 2007 \$44.95



1



2

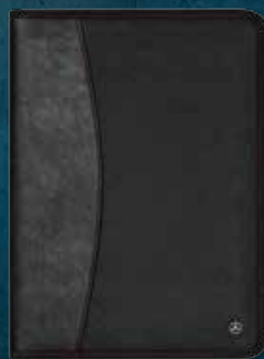

3



4

### 4 ACTROS KEY RING

Black/silver-coloured. Die-cast zinc. Actros outline on the front, Actros lettering on the rear. Split ring with three additional mini split rings for quick removal/replacement of individual keys. Length approx. 9.5 cm. B6 695 3825 \$51.95

**5 MOBILITY THERMAL FOOD CONTAINER, 1.2 L**  
Silver-coloured/black. Stainless steel. Double-walled. Keeps drinks cool for up to 12 h and hot for up to 6 h. 100% sealed. With integrated food compartment. Easy to clean. By esma for Mercedes-Benz. Dimensions approx. 17 x 15 x 17.3 cm. Capacity approx. 1.2 l. B6 787 2867 \$99.95

**6 MOBILITY THERMAL FLASK, 1.0 L**  
Silver-coloured/black. Stainless steel. Double-walled. Keeps drinks cool for up to 24 hours and hot for up to 12 hours. 100% sealed. With insulated drinking cup. By esma for Mercedes-Benz. Diameter approx. 8 cm, height approx. 30 cm. Capacity approx. 1.0 l. B6 787 2866 \$89.95

**7 THERMAL CUP, 0.36 L**  
Silver-coloured/black. Stainless steel. Double-walled. Keeps drinks cool for up to 8 h and hot for up to 4 h.

Pushbutton opening. Drinking opening all points around 360 degrees. 100% sealed. Detachable sealing cap. Dishwasher safe. By esma for Mercedes-Benz. Diameter approx. 8.3 cm, height approx. 20 cm. Capacity approx. 0.36 l. B6 787 2874 \$59.95

**8 THERMAL CUP, 0.5 L**  
Silver-coloured/black. Stainless steel. Double-walled. Keeps drinks cool for up to 12 h and hot for up to 6 h. Pushbutton opening. Drinking opening all points around 360 degrees. 100% sealed. Detachable sealing cap. Dishwasher safe. By esma for Mercedes-Benz. Diameter approx. 8.3 cm, height approx. 24 cm. Capacity approx. 0.5 l. B6 787 2875 \$69.95



5

6

7

8





1



2

**1 TOUQUE**

Black/white. 100% polyacrylic. With turnover fold. Actros lettering. B6 787 1437 \$33.95

**2 MEN'S T-SHIRT**

Black/silver-grey. 100% cotton. Reflective print. Modern fit. Actros vehicle silhouette on the front. Embroidered Mercedes star on left sleeve. Sizes: S-XXL. B6 787 1251-1256 \$40.95



6

**6 ZIPPO® LIGHTER**

Matt chrome brass. Stylised, laser-engraved ACTROS front. By Zippo® for Mercedes-Benz. Made in USA. Dimensions approx. 4 x 6 x 1.5 cm. B6 787 2020 \$112.95



3-4

**3 MEN'S 2-IN-1 JACKET**

Black/red. 100% polyester. Windbreaker with removable hood and cord to adapt the width. Quilted inner jacket with stand-up collar. Metal underarm ventilation eyelets. Reflective inserts on front and back. Reflective print on the hood, sleeves and back. Cuffs with adjustable Velcro fastening. High closing front zipper. Various pockets. Loose fit. Sizes S-XXXL. B6 787 1233-1238 \$216.95

**4 MEN'S DRIVER'S BOMBER JACKET**

Black/red. Outer material 100% polyester with PU coating, inner lining and padding: 100% polyester. Stand-up collar, waistband and cuffs made of ribbed material. Metal underarm ventilation eyelets. Reflective piping on front and back. Reflective print on back. High closing front zipper. Various pockets. Loose fit. "Mercedes-Benz Trucks you can trust" print on left chest, silver Mercedes star print on left upper arm. Sizes S-XXXL. B6 787 1227-1232 \$132.95



5

**5 CHILDREN'S CAP**

Black/red. 100% polyester. Actros radiator grille and Mercedes star embroidered on front section, Actros embroidered on back section. Adjustable fit. B6 787 1303 \$33.95



7

**7 WASH BAG**

Black/red. Polyester. Hanger accessory. Various pouches and mesh pockets. Removable mirror. Clip fastener. Dimensions approx. 50 x 30 cm. B6 787 1198 \$33.95

**8 REVERSIBLE FLEECE BLANKET**

Black/anthracite. 100% polyester. Surrounding border. Size approx. 150 x 200 cm. B6 787 2010 \$67.95



8

FRAAS  
THE SCARF COMPANY



**USE THE WALLET FUNCTION OF YOUR SMARTPHONE**

Simply scan the QR code and you will have the opportunity to clearly store the high-quality personal accessories from the Mercedes-Benz Collection on your mobile phone. Once stored, you are always up to date, wherever you are.



#### MEN'S JACKET

Black. 87% polyester/13% elastane. Dual-Thermo-R for ideal temperature control. Stowable hood. Removable sleeves. Pocket on bottom front. Regular fit. By PUMA for Mercedes-Benz. Sizes: XS-XXL.  
B6 799 6335-6340  
\$242.95

#### MEN'S AUTOMATIC CHRONOGRAPH, MOTORSPORTS

Stainless steel case with PVD coating. Black dial. Steel-coloured hour and minute hands, blue second hand, tips with Super-LumiNova® detail. Anti-reflective sapphire glass on both sides. Black leather strap. Water-resistant to 10 ATM. Diameter 43 mm. ETA 7750 automatic movement. Swiss made. B6 695 4398  
\$2,161.95

#### MEN'S POLO SHIRT

100% cotton. Button front. Stripe print on sleeves. Neck band in contrasting colour. Regular fit. By PUMA for Mercedes-Benz. Sizes XS-XXL.

**Indigo**  
B6 799 6353-6358  
**Black** (not shown)  
B6 799 6294-6299  
\$83.95

#### MEN'S SHORTS

Black. 70% polyester / 30% viscose. Textured double-knit material. Side pockets with zips. Regular bermuda fit. By PUMA for Mercedes-Benz. Sizes: XS-XXL.  
B6 799 6364-6369  
\$91.95



All products on this page



## The stuff that legends are made of.

The Mercedes-Benz Silver Arrows are legendary. The associated Mercedes-Benz Motorsport Collection takes up the design and performance of the Formula cars and moves them from the race track onto the road. The design characterised by black and silver and the range influenced by high-tech materials radiate uncompromising sportiness.



THE MERCEDES-BENZ MOTORSPORTS COLLECTION



1-2

All products on this page



3-4

**1 MEN'S T-SHIRT**

Black. 100% cotton. PUMA DryCELL technology. Neck band in contrasting colour. Regular fit. MERCEDES AMG PETRONAS MOTORSPORT logo print. MERCEDES AMG PETRONAS MOTORSPORT neck band. PUMA Cat logo on shoulder. By PUMA for Mercedes-Benz. Sizes: XS-XXL. B6 799 6225-6230 \$60.95

**2 MEN'S T-SHIRT**

Indigo blue. 100% cotton. Neck band in contrasting colour. Regular fit. Graphic print on front and rear section with MERCEDES AMG PETRONAS MOTORSPORT logo. PUMA Cat logo on shoulder. By PUMA for Mercedes-Benz. Sizes: XS-XXL. B6 799 6231-6236 \$60.95

**3 MEN'S T-SHIRT**

Black. 100% cotton. Neck band in contrasting colour. Valtteri Bottas graphic print on the front. Regular fit. MERCEDES AMG PETRONAS MOTORSPORT logo badge, PUMA Cat logo on the shoulder. By PUMA for Mercedes-Benz. Sizes: XS-XXL. B6 799 6243-6248 \$68.95

**4 MEN'S T-SHIRT**

Black. 100% cotton. Neck band in contrasting colour. Lewis Hamilton signature on front. Graphic print on back. Regular fit. MERCEDES AMG PETRONAS MOTORSPORT logo badge, PUMA Cat logo on the shoulder. By PUMA for Mercedes-Benz. Sizes: XS-XXL. B6 799 6237-6242 \$68.95



5

**5 MEN'S POLO SHIRT**

74% nylon/26% polyester. Optimum temperature control due to strategically positioned knitted structures. evoKnit technology. Zip fastening. "Slim but modified" fit. By PUMA for Mercedes-Benz. Sizes: XS-XXL.

**Silver-coloured** B6 799 6271-6276  
**Black** (not shown) B6 799 6255-6260 \$99.95

All products on this page



**6 MEN'S SWEAT JACKET**

70% polyester/30% viscose. Textured double-knit material. Hood can be adapted using cords. Side pockets with zips. Regular fit. By PUMA for Mercedes-Benz. Sizes: XS-XXL. B6 799 6316-6321 \$168.95



6

**7 MEN'S SWEAT JACKET**

70% polyester/30% viscose. Textured double-knit material. Hood can be adapted using cords. Side pockets with zips. Regular fit. By PUMA for Mercedes-Benz. Sizes: XS-XXL. B6 799 6285-6290 \$168.95



7

**8 LIGHTWEIGHT MEN'S JACKET**

Black. 100% nylon. Jacket can be stored in hood. Reflective stripes on sleeves. Ergonomic fit thanks to raglan style. Elastic cuffs and waistband. Regular fit. By PUMA for Mercedes-Benz. Sizes: XS-XXL. B6 799 6322-6327 \$168.95

**9 MID LAYER, MEN'S**

Black. 55% nylon/45% cotton. Optimum temperature control. evoKnit technology. Zip on the side. "Regular but modified" fit. By PUMA for Mercedes-Benz. Sizes: XS-XXL. B6 799 6341-6346 \$229.95



8



9



1



2



#### USE THE WALLET FUNCTION OF YOUR SMARTPHONE

Simply scan the QR code and you will have the opportunity to clearly store the high-quality personal accessories from the Mercedes-Benz Collection on your mobile phone. Once stored, you are always up to date, wherever you are.

#### 1 LIGHTWEIGHT MEN'S JACKET

Black. 100% polyester. Zip fastening. Cuffs on sleeves and hip. Various pockets. MERCEDES AMG PETRONAS MOTORSPORT logo on front. Regular fit. Sizes XS-XXL. B6 799 6071-6076 \$156.95

#### 2 MUG

Black. Ceramic. MERCEDES AMG PETRONAS MOTORSPORT logo on front. Three-coloured circle on bottom of mug. Capacity approx. 0.3 l. B6 799 5497 \$30.95

#### 3 RUCKSACK

Black. 100% polyester/30% nylon. Various compartments. Three-coloured press stud on right carrying handle. MERCEDES AMG PETRONAS MOTORSPORT logo on front. Dimensions approx. 25x13x44 cm. B6 799 5499 \$124.95

#### 4 SPORTS BAG

Black/Petronas green. 100% polyester/25% nylon. Large main pocket, small closable front pocket. Adjustable shoulder belt. Three-coloured press stud on the right-hand side. MERCEDES AMG PETRONAS MOTORSPORT logo print on front. Dimensions approx. 52x27x39 cm. B6 799 5498 \$144.95



3-4

#### 5 MEN'S MOTORSPORT CHRONO SILVER CHRONOGRAPH WATCH

Stainless steel case with black PVD coating and pushpiece with blue outlay. Silver-coloured dial made from genuine carbon fibre, graduated design, with Super-LumiNova® luminous dots and blue accents. Textile strap made from nylon with underside in leather. Black luminous hands. Blue second hand. Stopwatch function. Water-resistant to 10 ATM. Diameter approx. 45 mm. Ronda 5030 Swiss quartz movement. Swiss movt. B6 799 5428 \$538.95

#### 6 MEN'S MOTORSPORT CHRONO BLACK CHRONOGRAPH WATCH

Stainless steel case with black PVD coating and pushpiece with blue outlay. Black dial made from real carbon fibre, graduated design, with Super-LumiNova® luminous dots and blue accents. Stainless steel bracelet strap. Steel-coloured luminous hands. Blue second hand. Stopwatch function. Water-resistant to 10 ATM. Diameter approx. 45 mm. Ronda 5030 Swiss quartz movement. Swiss movt. B6 799 5426 \$622.95

#### 7 MEN'S AUTOMATIC CHRONOGRAPH, MOTORSPORTS

Stainless steel case with PVD coating. Black dial. Steel-coloured hour and minute hands, blue second hand, tips with Super-LumiNova® detail. Anti-reflective sapphire glass on both sides. Black leather strap. Water-resistant to 10 ATM. Diameter 43 mm. ETA 7750 automatic movement. Swiss made. B6 695 4398 \$2,161.95



5-7

#### 8 LADIES' T-SHIRT

White. 44% modal/42% cotton/14% nylon. Three-coloured neck band. Three-coloured circle on the right sleeve. MERCEDES AMG PETRONAS MOTORSPORT logo print on front, "77" print on front, Bottas "Seventy Seven" print on back. Regular fit. Sizes XS-XL. B6 799 6205-6209 \$51.95

#### 9 LADIES' T-SHIRT

White. 44% modal/42% cotton/14% nylon. Three-coloured neck band. Three-coloured circle on the right sleeve. MERCEDES AMG PETRONAS MOTORSPORT logo print on front, "44" print on front, Hamilton "Forty Four" print on back. Regular fit. Sizes XS-XL. B6 799 6185-6189 \$51.95

#### MEN'S T-SHIRT (NOT SHOWN)

Black. 100% cotton. Tricoloured neck band. Tricoloured circle at top of back panel. MERCEDES AMG PETRONAS MOTORSPORT logo print on left sleeve, "77" print on back, Bottas "Seventy Seven" print on the front. Regular fit. Sizes: XS-XXL. B6 799 6425-6430 \$51.95

#### MEN'S T-SHIRT (NOT SHOWN)

Black. 100% cotton. Tricoloured neck band. Tricoloured circle at top of back panel. MERCEDES AMG PETRONAS MOTORSPORT logo print on left sleeve, "44" print on back, Hamilton "Forty Four" print on the front. Regular fit. Sizes: XS-XXL. B6 799 6374-6379 \$51.95



8

9



10

#### 10 DRAWSTRING SPORTS BAG

Black. 100% polyester. Main compartment with tunnel drawstring. With front compartment with zipper fastening. MERCEDES AMG PETRONAS MOTORSPORT logo on front. Dimensions approx. 48x28x32 cm. B6 799 6215 \$36.95



1-2

### 1 WOMEN'S POLO SHIRT, DRIVER

Black. 95% cotton/5% elastane. Striped strap on sides, on the back of the collar as well as on the button band. Slim fit. Sizes XXS-XL.  
B6 799 6525-6530  
\$102.95

### 2 MEN'S POLO SHIRT, DRIVER

Black. 95% cotton/5% elastane. Striped strap on sides, on the back of the collar as well as on the button band. Slim fit. Sizes: XS-XXL.  
B6 799 6515-6520  
\$102.95

### 3 CHILDREN'S DRIVER T-SHIRT

95% cotton/5% elastane. Short sleeves. Striped band on sides and on the back of the collar. Mercedes-Benz logo print. Various sponsor logos. Regular fit. Sizes 92-164.

**Black** B6 799 6475-6481  
**White** (not shown) B6 799 6605-6607  
\$59.95

### 4 MEN'S DRIVER T-SHIRT

95% cotton/5% elastane. Short sleeves. Striped band on sides and on the back of the collar. Mercedes-Benz logo print. Various sponsor logos. Regular fit. Sizes: XS-XXL.

**Black** B6 799 6435-6440  
**White** (not shown) B6 799 6445-6448  
\$80.95

### 5 WOMEN'S T-SHIRT, DRIVER

95% cotton/5% elastane. Short sleeves. Striped strap on sides and on the back of the collar. Mercedes-Benz logo print. Various sponsor logos. Regular fit. Sizes XXS-XL.

**Black** B6 799 6535-6540  
**White** (not shown) B6 799 6545-6550  
\$84.95

### 6 MEN'S SOFTSHELL JACKET, TEAM<sup>1</sup>

Black. 100% polyester. Water-repellent front zipper. Zipped side pockets with a carbon fibre print. Stripe detail on the back of the collar. Mercedes-Benz embroidered logo. Regular fit. Sizes XS-XXL.  
B6 799 6495-5000  
\$206.95



6



3-5

### MEN'S SHIRT, TEAM (NOT SHOWN)<sup>1</sup>

White. 80% cotton, 20% polyester. Official MERCEDES AMG PETRONAS MOTORSPORT team shirt for the 2019 Formula 1 season. Short sleeves. Button-down collar. Concealed button band. Breast pocket. Striped strap on sides and on the back of the collar. Regular fit. Mercedes-Benz embroidered logo, various sponsor logos. Sizes XS-XXL. B6 799 6505-6510  
\$132.95

### MEN'S PULLOVER, TEAM (NOT SHOWN)<sup>1</sup>

Grey. 100% cotton. Striped pattern on cuffs. Regular fit. Mercedes-Benz embroidered logo. Various sponsor logos. Sizes XS-XXL.  
B6 799 6575-6580  
\$206.95



7



8

### 7 TOUQUE, TEAM

Grey. 100% cotton. Coloured stripes on the edge. Embroidered Mercedes-Benz logo on the front. Official MERCEDES AMG PETRONAS Motorsport team beanie for the 2018 Formula 1 season.  
B6 799 6125  
\$57.95

### 8 MEN'S CAGOULE, TEAM<sup>1</sup>

Black. 100% polyester. Water-repellent front zipper. Zipped side pockets with a carbon fibre print. Adjustable cuffs. Width adjustment. Reflector details. Stowable hood. Regular fit. Sizes XS-XXL.  
B6 799 6565-6570  
\$235.95



9-10

### 9 TEAM CAP

100% polyester. MERCEDES AMG PETRONAS MOTORSPORT logo on sides. Sandwich peak with lettering. Metal clasp for adjusting fit.

**Black** B6 799 6216  
**White** (not shown) B6 799 6217  
\$62.95

### CHILDREN'S CAP, HAMILTON (NOT SHOWN)

Black. 100% polyester. Mercedes star on front, MERCEDES AMG PETRONAS MOTORSPORT logo on side, sandwich peak with "Never Give Up" lettering. Metal fastener on back. B6 799 6251  
\$62.95

### 10 HAMILTON FLAT BRIM CAP

Black. 100% polyester. With flat brim. Lewis Hamilton wings logo and MERCEDES AMG PETRONAS MOTORSPORT logo on back. GRAN TURISMO logo on the side. Monster Energy<sup>®</sup> logo on the underside of the brim. Embroidered "44". Plastic fastener on back.

**Black** B6 799 6249  
**White** (not shown) B6 799 6250  
\$71.95

### HAMILTON CAP (NOT SHOWN)

100% polyester. Lewis Hamilton wings logo and MERCEDES AMG PETRONAS MOTORSPORT logo on back. GRAN TURISMO logo on the side. Monster Energy<sup>®</sup> logo on the underside of the brim. Embroidered "44". Sandwich peak with "Powerful Beyond Measure" lettering. Plastic fastener.

**Black** B6 799 6218  
**White** (not shown) B6 799 6219  
\$71.95

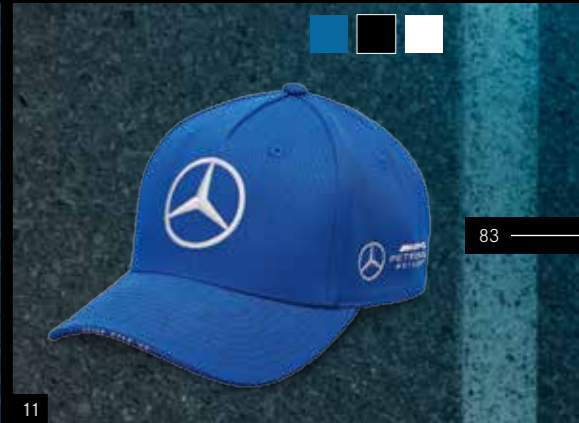

11

### 11 BOTTAS CAP

100% cotton. Valtteri Bottas logo on the back. MERCEDES AMG PETRONAS MOTORSPORT logo on sides. Monster Energy<sup>®</sup> logo on the underside of the brim. Metal clasp for adjusting fit.

**Blue** B6 799 6277  
**Black** (not shown) B6 799 6278  
**White** (not shown) B6 799 6279  
\$71.95

**AMG CAP**

White. Outer material 100% polyester.  
Lining 100% cotton. Metal clasp for adjusting fit.  
B6 695 2707  
\$43.95

**AMG LADIES' PERFORMANCE JACKET**

Black /white. 100% polyester. Water and windproof.  
Breathable. Openings on front and rear for additional  
ventilation. Purtext® waterproofing. Dual-Protection-  
System®. Size-adjustable hood. Width-adjustable  
sleeves. Extended elastic cuffs with thumb hole.  
Various pockets. Modern fit. White AMG 3D logo  
print on chest, AMG logo print on the inside on the  
back, white lining separation band featuring black  
AMG logo, pocket with white AMG 3D logo print.  
Sizes XS-XL.  
B6 695 8651-8655  
\$438.95

**AMG LADIES' POLO SHIRT**

See p. 86



SCAN THE QR CODE AND EXPERIENCE  
THE COLLECTION.

[http://mb4.me/MBA\\_AMG\\_Collection](http://mb4.me/MBA_AMG_Collection)

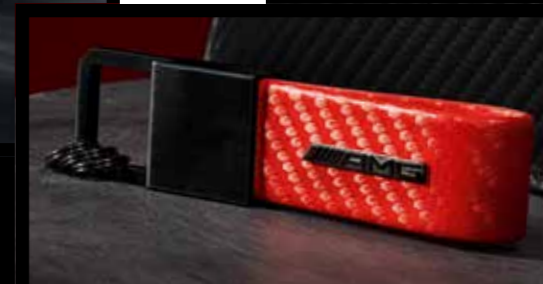

# High-performance meets high-fashion.

Athletic. Provocative. Stylish. This Mercedes-AMG Collection is dedicated to those who live an urban lifestyle. The strong contrast of black and white, perforated fabrics, sporty cuts and high-quality materials exemplify a cool nonchalance. For all those who are confidently for a statement.

AMG C 63 S Cabriolet: Fuel consumption combined:  
10.4 l/100 km, CO<sub>2</sub> emissions, combined: 236 g/km.



THE MERCEDES-AMG COLLECTION

**1 AMG FLAT BRIM CAP**

Black. 80% polyacrylic/20% wool. 5-panel cap. Adjustable fit. B6 695 4289 \$37.95



1



2-3

**2 AMG LADIES' T-SHIRT**

Black/white. 95% cotton/5% elastane. Short sleeves. Crew neck. White neck band with black AMG logo. White AMG logo print on inside of back. Two-tone AMG 3D logo print on chest. Slim fit. Sizes XS-XL. B6 695 8739-8743 \$78.95

**3 AMG MEN'S T-SHIRT**

Black/white. 95% cotton/5% elastane. Short sleeves. Crew neck. White neck band with black, woven AMG logo, white AMG logo print with size on inside of back, two-tone AMG 3D logo print on chest. Slim fit. Sizes: XS-XXL. B6 695 8733-8738 \$78.95

**4 AMG LADIES' POLO SHIRT**

Black/white. 95% cotton/5% elastane. Short sleeves. Two-tone zip. Side vents. Collar and cuffs with single rib. Cuffs with white, knitted stripe. White neck band and side groove band with a black, woven AMG logo. White AMG logo print on inside of back. Black AMG logo print on the zip bar. AMG logo on Autolock zip puller. Slim fit. Sizes: XS-XL. B6 695 8728-8732 \$117.95



4



5

6

7

8

**5 AMG MEN'S PERFORMANCE JACKET**

Black. 100% polyester. Water and windproof. Breathable. Zips on underside of sleeve for additional ventilation. Purtext® waterproofing. Dual-Protection-System®. Size-adjustable hood. Width-adjustable sleeves. Extended elastic cuffs with thumb hole. Various pockets. Modern fit. White AMG 3D logo print on chest, AMG logo print on the inside on the back, black lining separation band featuring white AMG logo, pocket with white AMG 3D logo print. Sizes: S-XXL. B6 695 8646-8650 \$438.95

**6 AMG MEN'S POLO SHIRT**

White/black. 95% cotton/5% elastane. Short sleeves. Two-tone zip. Side vents. Single-rib collar. Black neck tape and side vent band with white, woven AMG logo. Black AMG logo print on inside of back. Black AMG logo print on the zip bar. AMG logo on Autolock zip puller. Slim fit. Size: S-XXL. B6 695 8676-8680 \$117.95

**7 AMG CAP**

Black. Outer material 100% polyamide. Lining 100% cotton. Metal clasp for adjusting fit. B6 695 2706 \$43.95

**8 AMG ESSENTIALS SUNGLASSES**

Gunmetal stainless steel frame, partially brushed. Grey-graded lenses by Carl Zeiss Vision. 100% UV-A/UV-B protection (UV-400). Filter category 3. Anti-reflective coating and hardened. Upper side piece, side piece ends and nose pads with AMG diamond. Made in Germany. B6 695 3478 \$598.95

**1 AMG SNAP-HOOK KEY RING**

Black/red. Stainless steel/carbon fibre/aluminium. Snap-hook with twist action to open. Three additional mini split rings for quick removal/replacement of individual keys. Length approx. 10 cm. B6 695 3430 \$115.95



**2 MERCEDES-AMG GT R TYPO KEY RING**

Silver/black/yellow/green. Stainless steel/carbon fibre. Flat split ring with three additional mini split rings for quick removal/replacement of individual keys. Front features replica of original "GT R" lettering on rear of vehicle, back features AMG logo. Designed in Germany. Length approx. 9 cm. B6 695 3340 \$127.95

**3 MERCEDES-AMG GT TYPO KEY RING**

Silver/black/yellow. Stainless steel/carbon fibre. Flat split ring with three additional mini split rings for quick removal/replacement of individual keys. Front features replica of "GT" lettering on rear of vehicle, back features AMG logo. Designed in Germany. Length approx. 9 cm. B6 695 3339 \$127.95

**4 AMG TYPO KEY RING**

Silver/black/red. Stainless steel/carbon fibre. Flat split ring with three additional mini split rings for quick removal/replacement of individual keys. AMG logo on front. Designed in Germany. Length approx. 9 cm. B6 695 3338 \$127.95



**5 AMG CASE FOR iPhone® 7**

Black/silver. Plastic/aluminium. Hard case in real-carbon fibre. Engraved "AMG" lettering. Suitable for wireless charging. B6 695 4031 \$65.95

**6 AMG COVER**

Black/carbon-coloured. Polycarbonate/polyurethane/carbon fibre. Apertures for camera, buttons and connections. AMG logo. Suitable for wireless charging. iPhone® XR B6 695 6003 \$63.95  
iPhone® X/iPhone® XS (not shown) B6 695 3702 \$98.95  
Samsung Galaxy S8 (not shown) B6 695 3704 \$98.95

**7 AMG BOOKTYPE COVER**

Black/carbon-coloured. Polycarbonate/polyurethane/carbon fibre. Apertures for camera, buttons and connections. AMG logo. Suitable for wireless charging. iPhone® X/iPhone® XS B6 695 3701 \$122.95  
iPhone® 8 Plus (not shown) B6 695 8625 \$95.95  
iPhone® 8 (not shown) B6 695 8624 \$88.95  
Samsung Galaxy S8 (not shown) B6 695 3703 \$122.95

**8 AMG TO GO CUP, 0.5 L**

Black. Stainless steel. Silicone wrist strap. Functional drinking cap. Double-walled. By eva solo for Mercedes-AMG. Diameter approx. 7.5 cm, height approx. 20 cm. Capacity approx. 0.5 l. B6 695 5082 \$85.95

**9 AMG ESPRESSO CUPS, SET OF 2**

Black/white. Porcelain. Carbon fibre-look design on the outside of cups and on saucers. By Kahla for Mercedes-AMG. Made in Germany. Capacity approx. 90 ml. B6 695 3359 \$106.95

**10 AMG MUG**

Black/white. Carbon fibre-look design on outside. Porcelain. Magic Grip on base. By Kahla for Mercedes-AMG. Made in Germany. Capacity approx. 350 ml. B6 695 3358 \$51.95



eva solo

KAHLA  
PORCELAIN FOR THE SENSES



#### USE THE WALLET FUNCTION OF YOUR SMARTPHONE

Simply scan the QR code and you will have the opportunity to clearly store the high-quality personal accessories from the Mercedes-Benz Collection on your mobile phone. Once stored, you are always up to date, wherever you are.



1-2

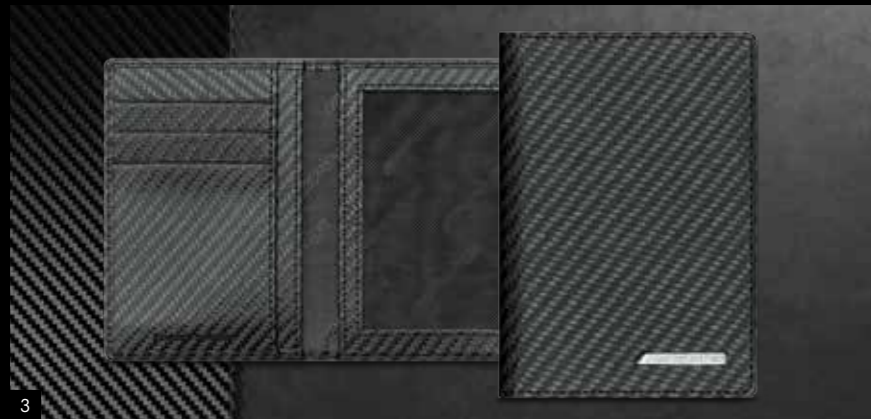

3

#### 1 AMG BALLPOINT PEN

Black. Brass/carbon fibre. Twist cap. Writes in blue. AMG logo on barrel. Made in Germany. B6 695 3498 \$299.95

#### 2 AMG SOUND BALL-POINT PEN

Black. Plastic. Writes in blue. Plays the engine sound of a Mercedes-AMG vehicle at the touch of a button. AMG logo on barrel. B6 695 3552 \$52.95

#### 3 AMG VEHICLE REGISTRATION WALLET

Black. Carbon-fibre-look leather. Transparent mesh compartment for vehicle registration documents. Various compartments for credit cards. Handmade in Germany. Dimensions approx. 12x0.8x8.5 cm. B6 695 9995 \$95.95



4

#### 4 MERCEDES-AMG G 65 USB FLASH DRIVE

White/black. Plastic/metal. 16 GB storage capacity. USB 2.0. Compatible with all standard operating systems. Dimensions approx. 7.8x2.6x2.8 cm. B6 695 3229 \$63.95

#### 5 AMG LAPTOP/TABLET

**CASE** Black. Carbon-fibre-look leather. For laptop/tablet sizes up to 13". High-quality AMG badge, lining material with tonal AMG logo. Dimensions approx. 35 x 25 x 2 cm. B6 695 4469 \$216.95

#### 6 AMG CREDIT CARD

**WALLET** Black. Carbon-fibre-look leather. Various card and banknote compartments. Handmade in Germany. Dimensions approx. 10.5 x 1.5 x 11.5 cm. B6 695 4552 \$172.95

#### 7 AMG MINI WALLET

Black. Carbon-fibre-look leather. Various compartments inside. Handmade in Germany. Dimensions approx. 10.5 x 1.5 x 7.5 cm. B6 695 9996 \$136.95

#### 8 AMG CARBON KEY CHAIN

Carbon fibre leather/stainless steel. Pull/twist mechanism. Three mini split rings for quick removal/replacement of individual keys. AMG logo on leather Length approx. 10 cm.

**Red** B6 695 3427

**Black** (not shown)

B6 695 3428

\$97.95



5

6

7

8

90

91



# Business unusual.

For all those who love high-performance in their job, this Collection combines business-chic with clear racing accents. The finest leather has the typical AMG touch, feel and look thanks to a perforation and diamond look. The same material also makes wallets even more valuable. Cool gunmetal sets accents and is reminiscent of the high-gloss detachable chrome parts of the AMG models.

## AMG BUSINESS SUNGLASSES

High-gloss dark green titanium frame, partially brushed. Grey-graded lenses by Carl Zeiss Vision. 100% UV-A/UV-B protection (UV-400). Filter category 3. Anti-reflective coating and hardened. Upper side and side pieces with elaborate embossing. Tension-controlled titanium mono-block hinges. Made in Germany. B6 695 3477  
\$805.95

## AMG MEN'S LEATHER JACKET

Black with silver grey and red contrasts. Outer material 100% exquisite nappa lambskin, lining: 100% viscose with antibacterial silver finish equipment. Removable collar with zipper. Perforated sections in the shoulder and sleeve area. Modern fit. AMG logo embossing and Heinz Bauer Manufakt logo on left sleeve and on inside on the back. By Heinz Bauer Manufakt for Mercedes-Benz. Sizes 48-56. B6 695 8641-8645  
\$3,702.95

## AMG BUSINESS KEY RING

Black/silver grey/gun. Leather/stainless steel. Split ring with three additional mini split rings for quick removal/replacement of individual keys. Made in Germany. Length approx. 11 cm. B6 695 3824  
\$181.95



Mercedes-AMG S 63 4 MATIC + Saloon: Fuel consumption, combined: 11.2 l/100 km; CO<sub>2</sub> emissions, combined: 255 g/km.

THE MERCEDES-AMG COLLECTION



**1 AMG WALLET**  
Black with red topstitching. Cowhide. Various compartments for notes, coins and cards. With embossed AMG logo. Handmade in Germany. Dimensions approx. 12.5x2x9.5 cm. B6 695 3227 \$204.95

**2 AMG BUSINESS BAG**  
Black with red topstitching. Cowhide. Zipped main compartment, various inner compartments. Additional compartment for laptop. Padded, adjustable shoulder strap. Leather loop at back for slotting over towbar of trolley suitcase. Handmade in Germany. Dimensions approx. 41x12x29 cm. B6 695 2986 \$883.95



**4 AMG BELT**  
Black with red contrasting stitching. Leather/stainless steel. Combination of grained and perforated leather. Handmade in Germany. Adjustable fit. Length approx. 120 cm. B6 695 4551 \$193.95



**5 AMG MEN'S POLO SWEATER**  
Black/silver grey. 60% extra fine merino wool/35% Lyocell/5% cashmere. Raglan sleeves. Collar, sleeves and hem rounded off with single-rib. Concealed button band. Slim fit. AMG label in side seam and neck seam. Sizes: S-XXL. B6 695 8666-8670 \$317.95



**6 CREDIT CARD HOLDER WITH MONEY CLIP**  
Black with red contrasts. Combination of grained and perforated leather. Stainless steel money clip. AMG inner lining. Handmade in Germany. Dimensions approx. 6.5x0.5x10 cm. B6 695 4541 \$115.95

**3 AMG WEEKEND BAG**  
Black with red contrasting stitching. Leather/nylon. Various compartments on inside and outside. Reinforced base with feet. Detachable, adjustable shoulder strap. Carrying handles and strap modelled on seat belt. With embossed AMG logo. Dimensions approx. 50x28x33 cm. Capacity approx. 34 l. B6 695 4554 \$582.95



**7 AMG MEN'S POLO**  
Black/silver-grey. 70% cotton/20% nylon/10% silk. Single-rib collar, cuffs and hem. Concealed double button band. Slim fit. Woven AMG label on the inside of the neck and in the side seam. Sizes: S-XXL. B6 695 8671-8675 \$201.95

**8 AMG I-CLIP THE WALLET**  
Black with silver-coloured details. Permanently elastic, high-tech plastic ROBUTENSE/original vehicle leather. Patented card system. For up to 12 cards. Money clip. Made in Germany. Dimensions approx. 8.7x6x1.6 cm. B6 695 4784 \$101.95

**9 AMG WALLET**  
Black. Cowhide. RFID protection. Various compartments for notes, coins and cards. Metal AMG badge. Handmade in Germany. Dimensions approx. 12x1.5x9.2 cm. B6 695 4137 \$226.95



# Driving statement.

No other colour has a more powerful effect than red. In the Mercedes-AMG Collection it sets glowing accents together with deep black. The high-quality items of clothing and personal accessories catch the eye as furiously as the AMG Grand Tourer and strike directly into the hearts of motorsport-inspired AMG fans. Every item is intended to give your wardrobe or your home sporty contours.

96

#### AMG LANYARD

Red/black. Nylon/metal/plastic. Carbon-fibre-look front part. Click-lock fastener. Snap hook and split ring. Safety clasp. Length approx. 53 cm, width approx. 2 cm. B6 695 3852  
\$42.95

#### AMG LADIES' VEST

Selenite grey/red/white. 100% polyester. Windproof. Warm. Detachable hood. Water-resistant zip. High-closing collar with chin guard. Various pockets. Slim fit. Sizes: XS-XL. B6 695 8563-8567  
\$257.95

#### AMG LADIES' POLO SHIRT

See p. 98

97



Mercedes-AMG GT Roadster: Fuel consumption combined: 11.5 l/100 km; CO<sub>2</sub> emissions, combined: 262 g/km.



THE MERCEDES-AMG COLLECTION

#### 1 AMG MEN'S POLO SHIRT

White with grey and black contrasts. 100% cotton piqué. Padding in shoulder area. Black AMG logo embroidered on front and on collar band. Large 3D AMG print on back in black. Sizes: S-XXL. B6 695 6772-6776 \$99.95

#### 2 AMG LADIES' POLO SHIRT

Black with white, red and grey contrasts. 95% cotton/5% elastane single jersey. Button bar with press-studs. Lightly padded shoulders. Slim fit. Large 3D AMG print on back. Sizes: XS-XL. B6 695 8293-8297 \$99.95

#### 3 MEN'S VEST

Selenite grey/red/black. 100% polyester. Detachable hood. Water-resistant zip. High-closing collar with chin guard. Various pockets. Slim Fit. Sizes S-XXL. B6 695 8533-8537 \$273.95

#### 4 AMG COMPACT UMBRELLA

Black/red. Aluminium/polyester. Special water and dirt-repellent coating. Windproof design. Automatic opening and closing. Aluminium shaft. Handle trimmed in perforated leather. Length approx. 58 cm. Diameter when open approx. 105 cm. B6 695 3676 \$149.95



1-2

98

3

4

5

6

7

99

#### 5 AMG GUEST UMBRELLA

Black/red. 100% polyester canopy. Perforated leather handle and matt chromed cap. Automatic opening. Special water and dirt-repellent coating. Windproof design. White logo print. Diameter when open approx. 105 cm. B6 695 3677 \$191.95

#### 6 AMG MEN'S PERFORMANCE JACKET

Selenite grey/black. 100% polyester. Wind and water-repellent coating. Detachable hood. Various inside pockets. Adjustable cuffs. Slim fit. White AMG logo print on front. Sizes: S-XXL. B6 695 7495-7499 \$293.95

#### 7 AMG MEN'S PERFORMANCE POLO SHIRT

Black/white/red. 100% Coolmax polyester. Breathable. Side inserts made of textured material. Single-rib collar and cuffs in single rib. Zip fastening. AMG logo on the chest, on the collar band and on the back. White neck band with a woven-in AMG logo. Slim fit. Sizes: S-XXL. B6 695 8553-8557 \$166.95



AMG GT R Coupé: Fuel consumption combined:  
12.4 l/100 km, CO<sub>2</sub> emissions, combined: 284 g/km.

# Hellishly chic.

The glowing green indicates the origin of the AMG GT R from afar, which spent a large part of its development time in the green hell of the Nürburgring. This collection generates additional attention. Turning little devils into little angels.

100

101

**CHILD'S MERCEDES-AMG GT R CAP**  
Selenite grey/green. Outer material 99% polyamide/  
1% elastane, Lining 100% cotton. Mercedes-AMG GT R  
"beast of the green hell" motif print on the front.  
AMG logo embossed on metal clasp. Adjustable fit.  
B6 695 3957  
\$37.95

**AMG CHILD'S T-SHIRT**  
Black/green. 100% cotton. Crew neck. Modern fit.  
Green neck band with black AMG logo, white logo  
print on inside collar patch, fluorescent "Beast of  
the Green Hell" print on the front, AMG logo print  
on back in reflective black Sizes 116/122-152/158.  
B6 695 4674-4677  
\$69.95

**AMG MEN'S HYBRID JACKET**  
See p. 102



THE MERCEDES-BENZ COLLECTION



**1 BOBBY BENZ AMG GT**  
 Plastic. Lights front and back. Whisper wheels.  
 Suitable for children aged 18 months and over. Manufacturer: BIG Spielwaren.  
**Solar beam (with LED lighting function)** B6 696 2000  
 \$258.95  
**Silver-coloured (not shown)** B6 696 1999  
 \$172.95

**2 MERCEDES-AMG ELECTRIC RIDE-ON CAR**  
 Maximum speed approx. 4–5 km/h. Age 3+. With EU and universal mains plug.  
 By INJUSA for Mercedes-Benz.  
**Mercedes-AMG GT S. Solarbeam. With LED and sound.** B6 696 3811  
 Please contact dealer for pricing  
**Mercedes-AMG GT. White (not shown)** B6 696 3810  
 Please contact dealer for pricing



**3 MERCEDES-AMG GT R USB FLASH DRIVE**  
 Green light magno/black. Plastic/metal. In the shape of the Mercedes-AMG GT R  
 vehicle. Die-cast body. 16 GB storage capacity. USB 2.0. Compatible with all  
 standard operating systems. Dimensions approx. 6.8 x 3 x 1.7 cm.  
 B6 695 3476  
 \$77.95

**4 MERCEDES-AMG GT R CAP**  
 In selenite grey with black, green and solar beam yellow contrasts. Outer  
 material 100% nylon. Lining 100% cotton. Black 3D GT R logo embroidered on  
 back. AMG logo embossed on metal clasp. Adjustable fit. B6 695 3207  
 \$43.95



**5 AMG MEN'S HYBRID JACKET**  
 Black/green. Material: Outer material: inside of hood and quilted as well as  
 padded sections: 100% nylon. Hood, collar, sleeves and side inserts in the front  
 and back section made from 100% polyester with fleece and anti-pilling polyester  
 wadding: PrimaLoft®. High-closing collar. Width- and size-adjustable hood. Adjust-  
 able sleeve width. Side pockets. Lightweight. Slim fit. Black AMG 3D logo print  
 on sleeve, green neck band with black AMG logo, AMG logo print with size on  
 inside of back. Sizes: S–XXL. B6 695 8744–8748  
 \$336.95



**6 MERCEDES-AMG GT R CHILD'S UMBRELLA**  
 Black/green. Canopy made from polyester, handle  
 made from sponge rubber. Wrist loop. Mercedes-AMG  
 GT R "beast of the green hell" motif print. Diameter  
 when open approx. 75 cm. Length when closed  
 approx. 62 cm. B6 695 5025  
 \$46.95

**7 AMG CHILD'S WATCH**  
 Green/yellow/black. Stainless steel/silicone.  
 Black dial with AMG GT R motif print and white  
 imprinted dials. Yellow hour and minute hands,  
 green second hand. Green silicon strap with  
 "beast of the green hell" print. Water-resistant  
 to 5 ATM. Diameter 30 mm. Japanese Citizen  
 Miyota 2035 quartz movement. B6 695 4228  
 \$132.95

**8 CHILD'S MERCEDES-AMG GT R GYM BAG**  
 Black/green. Polyester. Zipped compartment on  
 inside and outside. Clip on cord for improved wear  
 comfort. Mercedes-AMG GT R "beast of the green  
 hell" motif print on front, AMG lettering on drawstring  
 with AMG print on inside pocket. Dimensions  
 approx. 38 x 51 cm. B6 695 3966  
 \$54.95

## Filter categories for sunglasses

Four filter categories are used for sunglasses, based on the degree of tint. Please use the table below to decide which category best suits your needs.

CATEGORY	Tint	Protection/light conditions
1	20-57%	Light protection for overcast days
2	57-80%	Normal protection for summer days in Central Europe
3	80-92%	High protection for expanses of water, beaches and mountains, plus Southern European countries; from 90% tint not suitable for driving!
4	92-97%	Maximum protection for high mountains and glaciers; not suitable for driving!

## Clothing sizes

The tables below are designed to help you find your perfect size. It is important to take your measurements correctly. For best results, you should be relaxed and wearing only your underwear. Ideally you should use a tape measure which you should keep close to the body. If you have someone to help you, it will be easier and more precise.

- CHEST:** keeping the tape measure horizontal, measure around the fullest part of the chest
- WAIST:** measure around the waist without drawing the tape measure too tight
- HIPS:** keeping the tape measure horizontal, measure around the fullest part of the hips
- HEIGHT** (for children's clothing): measure from the top of the head to the sole of the feet without shoes

Please note: separate tables are provided for the PUMA brand and the official MERCEDES AMG PETRONAS MOTORSPORT clothing.

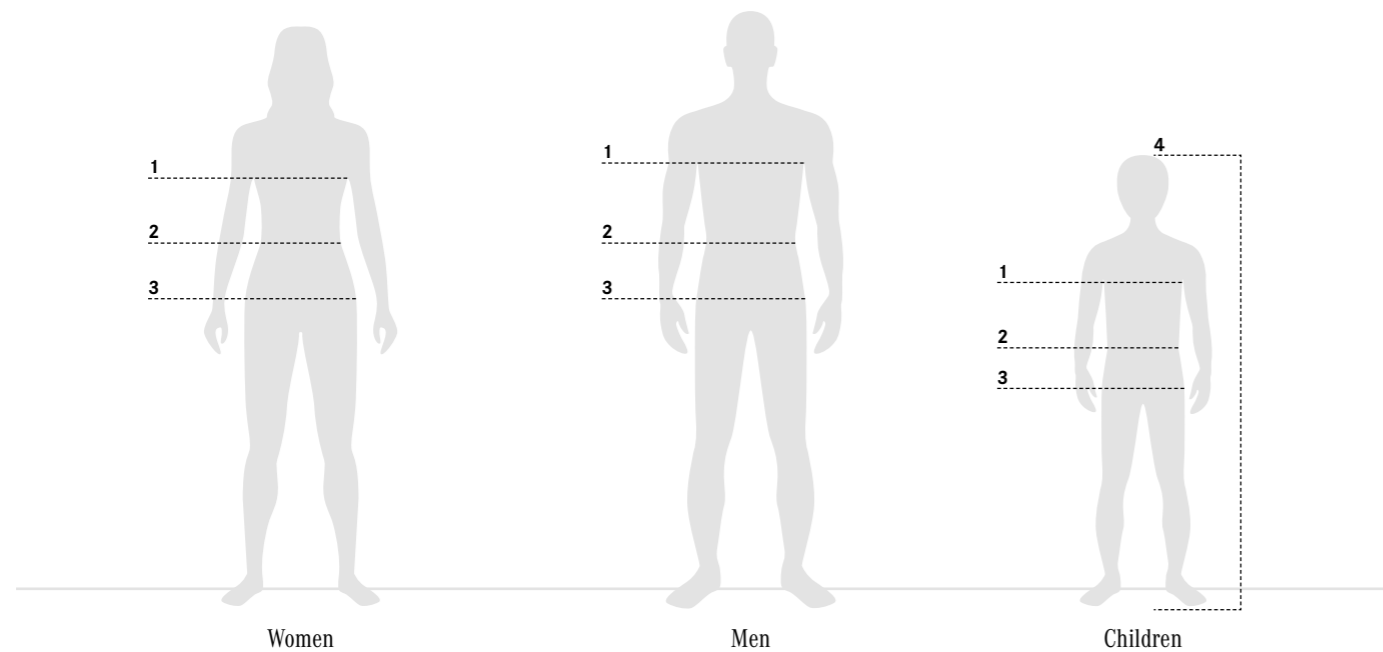

## Women

SIZE	XS	S	M	L	XL
CHEST (CM)	77-82	83-88	89-94	95-100	101-106
WAIST (CM)	61-66	67-72	73-78	79-84	85-90
HIPS (CM)	87-92	93-98	99-104	105-110	111-116

## Men

SIZE	XS	S	M	L	XL	XXL	XXXL
CHEST (CM)	85-90	91-96	97-102	103-108	109-114	115-120	121-126
WAIST (CM)	78-82	83-87	88-93	94-99	100-105	106-111	112-117
HIPS (CM)	89-94	95-100	101-106	107-112	113-118	119-124	125-130

## Children

SIZE	116/122	128/134	140/146	152/158
AGE (YEARS)	6-7	8-9	10-11	12
CHEST (CM)	58-62	63-68	69-74	75-80
WAIST (CM)	55-56	57-59	60-62	63-65
HIPS (CM)	62-67	68-73	74-80	81-87
HEIGHT (CM)	114-125	126-137	138-149	150-161



## Women

SIZE	XS	S	M	L	XL
CHEST (CM)	82	86	91	96	101
WAIST (CM)	65	68	74	80	86
HIPS (CM)	93	96	101	106	112

## Men

SIZE	XS	S	M	L	XL	XXL
CHEST (CM)	84	92	100	108	116	124
WAIST (CM)	76	82	88	96	104	114
HIPS (CM)	88	95	102	110	118	126

## Children

SIZE	104	116	128	140	152
CHEST (CM)	56	59	64	70	76
WAIST (CM)	53	55	59	63	67
HIPS (CM)	59	63	69	75	81
HEIGHT (CM)	104	116	128	140	152

Women

SIZE	XXS	XS	S	M	L	XL	XXL
CHEST (CM)	78	82	86	91	96	101	107
WAIST (CM)	62	65	68	74	80	86	114
HIPS (CM)	90	93	96	101	106	112	118

Men

SIZE	XXS	XS	S	M	L	XL	XXL	XXXL
CHEST (CM)	89	91	93	97	102	112	120	130
WAIST (CM)	77	79	81	85	92	105	114	122
HIPS (CM)	92	94	97	99	103	110	117	124

Children

SIZE	116/122	128/134	140/146	152/158
AGE (YEARS)	6-7	8-9	10-11	12
CHEST (CM)	58-62	63-68	69-74	75-80
WAIST (CM)	55-56	57-59	60-62	63-65
HIPS (CM)	62-67	68-73	74-80	81-87
HEIGHT (CM)	114-125	126-137	138-149	150-161

Women

SIZES	INTERNATIONAL EQUIVALENTS				
	DEU	UK	FRA	ITA	SP
XXS	32	6	34	36	36
XS	34	8	36	38	38
S	36	10	38	40	40
M	38	12	40	42	42
L	40	14	42	44	44
XL	42	16	44	46	46
XXL	44	18	46	48	48

Men

SIZES	INTERNATIONAL EQUIVALENTS				
	DEU	UK	FRA	ITA	SP
XXS	38	38	38	38	38
XS	40/42	40/42	40/42	40/42	40/42
S	44/46	44/46	44/46	44/46	44/46
M	48/50	48/50	48/50	48/50	48/50
L	52/54	52/54	52/54	52/54	52/54
XL	56/58	56/58	56/58	56/58	56/58
XXL	60/62	60/62	60/62	60/62	60/62

Children

SIZES	INTERNATIONAL EQUIVALENTS				
	DEU	UK	FRA	ITA	SP
XXS	104	3/4	4	104	4
XS	116	5/6	6	116	6
S	128	24/25	8	128	8
M	140	26/28	10	140	10
L	152	30/32	12	152	12
XL	164	32/34	14	164	14
XXL	176	34/36	16	176	16



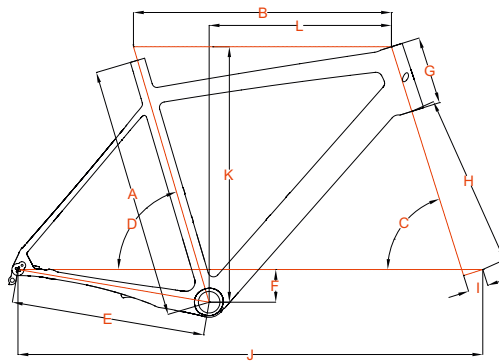

Size - Crater Lake Fitness Bike/Aventura Trekking Bike

	S	M	L	XL
HEIGHT (IN CM)	158-168	168-178	178-188	188-198
A FRAME SIZES	450 mm	500 mm	550 mm	600 mm
B TOP TUBE	570 mm	580 mm	595 mm	610 mm
C HEAD TUBE ANGLE	71°	71.5°	71.5°	71.5°
D SEAT TUBE ANGLE	74°	73.5°	73°	72.5°
E CHAIN STAY LENGTH	465 mm	465 mm	465 mm	465 mm
F BB DROP	60 mm	60 mm	55 mm	55 mm
G HEAD TUBE	135 mm	135 mm	170 mm	220 mm
H FORK LENGTH	465 mm	465 mm	465 mm	465 mm
I FORK RAKE	45 mm	45 mm	45 mm	45 mm
J WHEELBASE	1093 mm	1092 mm	1104 mm	1114 mm
K STACK	613 mm	616 mm	644 mm	691 mm
L REACH	394 mm	398 mm	398 mm	392 mm

Size - Raven Elite Carbon Mountain Bike

	XS	S	M	L
HEIGHT (IN CM)	158-168	168-174	174-184	184-196
A FRAME SIZES	380 mm	420 mm	460 mm	500 mm
B TOP TUBE	566 mm	592 mm	608 mm	629 mm
C HEAD TUBE ANGLE	69.5°	69.8°	69.8°	69.8°
D SEAT TUBE ANGLE	74.5°	74.5°	74.5°	74.5°
E CHAIN STAY LENGTH	425 mm	435 mm	435 mm	435 mm
F BB DROP	47 mm	68 mm	68 mm	68 mm
G HEAD TUBE	100 mm	104 mm	107 mm	130 mm
H FORK LENGTH	487 mm	501 mm	501 mm	501 mm
I FORK RAKE	44 mm	44 mm	44 mm	44 mm
J WHEELBASE	1074 mm	1100 mm	1116 mm	1139 mm
K STACK	580 mm	620 mm	623 mm	644 mm
L REACH	405 mm	420 mm	435 mm	450 mm